



Miniaturized Red Dot Systems for Duty Handgun Use

Fourth Edition, 2021

Aaron Cowan

Table of Contents

<u>Foreword</u>	3
<u>Intent</u>	4
<u>Summary</u>	5
<u>Technology</u>	6
Construction and Features	6
<u>Equipment Implementation</u>	9
External Mounts	9
Milled Slide	10
OEM Milled Slides	11
Modular Milled	12
Glock MOS Specific Aftermarket Adaptor Plate Testing	13
Duty Holsters	14
Optic Care	15
<u>Optic Durability</u>	16
Evaluated MRDS	16
Line of Duty Optic failures	19
<u>Visual and Mental Complications During a Use of Force</u>	22
Human Vision Under Stress	22
Mental Processing Under Stress	31
Sights in Reduced Lighting	32
Constant Threat Focus	35
Liability Under Traditional Training Methods	37
<u>Advantages of Red Dot Optics</u>	39
One Focal Plane	39
Accuracy Improvement with the MRDS	40
MRDS Use in Force on Force	45
<u>MRDS Adaptation and Training</u>	58
Selecting an MRDS Model	58
Fundamental Level Instruction	59
Addressing Optic Failure in Training	63
Department Approval, Implementation and Training Plan Creation	68
Conclusion	72

Foreword

This document marks the culmination over 7 years of research, testing, field use and evaluation of miniaturized red dot sight (MRDS) for duty purposes. The original hypothesis was; that a MRDS is not only more efficient than traditional iron sights for the duty handgun, but that the MRDS would provide distinct advantages not possible with proper iron sight use.

Specifically, MRDS would allow a shorter learning period to proper accuracy for mandated firearms training and qualification, and allow officers to maintain proficiency easier due to the less complex optical methods used to properly aim with the MRDS.

Additionally, the MRDS allows the officer to maintain a constant focus on the target, which can significantly improve threat awareness, help mitigate mistake of fact shootings and aid in more precise round placement over traditional iron sights.

This document is available publicly and may be used for justification, policy and/or research purposes, so long as it is cited in its entirety without modification or editing and credit is given to the original author.

Cited documents are property of their respective authors and sources.

Intent

The critical nature of accuracy is a well-studied and often criticized aspect of law enforcement. The general standards for officer accuracy have traditionally been driven by policy, mandated qualifications that provide official records of an individual's ability to meet an administrative standard.

This administrative standard, while important, only speaks to a criterion for record and may not accurately measure an officer's accurate skill during a use of force situation.

The core purpose of an officer's accuracy is to defend life. Society has trusted our officers with the ability to use force and they are expected to be good at it. It falls on a department to give their training cadre, range instructors and individual officers all the tools they need to meet and exceed this trust.

To meet this mandate, departments must be prepared to embrace new technology, properly vetted, and evaluate its necessity for their officers. If a new methodology or technology can improve officer effectiveness and aid in reducing mistake-of-fact use of force, then it is imperative that it be made available to officers.

This document was created to give administrators, range masters and officers the information they need to make an informed decision on the testing and implementation of MRDS equipped duty handguns.

Summary

This document lays out the understanding and advantages for adoption of miniaturized red dot optics for law enforcement duty handguns. Establishing that human psychophysiology is not best served with traditional iron sight method of aiming, the red dot is a superior method of aiming due to the correct nature of use in which the officer can remain threat focused instead of having to complete multiple focal point changes before force can be used.

Furthermore, the adoption of red dot optics can go far to preventing mistake of fact shootings under the same advantage; the officer maintains a constant focus on the threat, providing focused information on the threat up to and throughout a use of force. In this method, an officer will better be able to detect any change in the threats actions or inactions that may be missed with traditional iron sight use, therefore giving a distinct advantage in this area as well.

Specific studies on red dot use in live fire and force on force, showing clear advantages in accuracy and consistency are presented, with in-depth analysis of conditions that allow the red dot optic to succeed so well over traditional sighting systems.

Law enforcement liability, and how the red dot optic can greatly aid a department in reducing potential liability in officer involved shootings is explored, pointing to how red dots can better address existing Supreme Court decisions that drive training policies.

Also advantageous under reduced lighting conditions, the red dot is shown to excel over traditional iron sight methods, aiding an officer to provide more accuracy despite conditions that usually reduce officer accuracy.

Misunderstandings with red dot reliability are addressed and expelled or mitigated with information on training for the potential failures that do exist.

This white paper is not exhaustive; however, it addresses every foreseen aspect of red dot adoption or permission for law enforcement duty handguns known at this time. It is clearly shown that the advantages of red dot optics greatly outweigh the negatives and though a relatively innovative technology when compared to traditional iron sights, the red dot can and will greatly reduce the low averages of law enforcement accuracy in uses of force.

Technology

Early in 2013, Sage Dynamics began multiple studies and evaluations regarding Miniaturized Red Dot Sights (MRDS) for handguns. The red dot optic has already been established as a preferred and advantageous method of aiming for rifles in the military, law enforcement and self-defense world, however the technology as applied to handguns in 2013 was relatively new on a wide scale and viewed with justified caution.

The technology behind the MRDS is not unlike that found in rifle specific red dot optics; a light emitting diode projects through collimating optics to give the shooter a red dot point of aim. The technology used in red dots for small arms goes back as far as the late Vietnam War for functional use in military operations¹, and over the decades since its introduction has become the preferred method of deliberate aiming, especially in close quarter shooting. With continual improvements in materials and circuitry, red dot sights such as those made by Aimpoint and Trijicon (among others) have incredible battery life and robust durability.

The *miniaturized* red dot optic is newer, relatively speaking, however the established lineage of using a red dot optic on a handgun has a long history of its own. First used in competition shooting in the late 1970's² and early 1980's with optics from Aimpoint and later C More systems, red dots on handguns saw increasing popularity in IPSC and USPSA. As with many things, the technology being used in competitions began to drift into self-defense shooting, though it was not until pistol optics became truly miniaturized that they could be added to a handgun without need for complicated holsters or extensive modification to handguns.

Currently there are dozens of MRDS options on the market and their quality varies greatly from brand to brand. This paper specifically sites the use of the Trijicon Ruggedized Miniature Reflex. Since its brand introduction in 2007, the RMR has established itself as the most consistently reliable MRDS available. During the research period, multiple options were explored for reliability and technological advantage and each time the Trijicon RMR remained the best choice.

In 2017 Trijicon introduced the Type 2 RMR, offering further reliability improvements with pistol use specifically in mind. Reliability will be addressed in depth later on.

Specific features discussed hereafter, unless noted otherwise, address those offered by the RMR MRDS.

Construction and Features

MRDS point of aim (POA) projected dots are delivered in three methods, each with its own advantages and disadvantages. These POA come in multiple sizes and varied physical colors. Optic bodies vary

¹ The Raid, Benjamin F. Schemmer, Avon Books (1986)

² Jerry Barnhart used an Aimpoint Electronic in IPSC competition, circa 1970s. A History of Pistol Mounted Red Dots, Guns and Ammo Online, Patrick Sweeny (2016)

slightly between LED and adjustable LED models (the inclusion of adjustment buttons in the latter) and in dual illumination with a light collecting panel present on the top of the optic.

Operating System:

- **Battery powered LED**
The battery powered LED is a non-user adjustable LED that automatically adjusts to ambient lighting conditions via a photoreceptor. This method of operation is the earliest technology for the MRDS. Red is the common POA color.
- **Battery Powered Adjustable LED**
The battery powered adjustable LED allows the user to manually adjust brightness, or set in an *auto* mode where LED brightness will be adjusted by a photoreceptor just like the non-adjustable LED. Red is the common POA color.
- **Dual Illumination**
Dual illumination uses tritium and fiber optics to project a point of aim; under day light or photopic artificial light, fiber optics is the primary source of POA. In low light, the POA is projected via channeled tritium. Amber and green are the offered POA colors.

Reticle:

- **Minute of Angle (MOA) dot**
By far the most prevalent reticle option, MRDS dots are projected in 1 MOA, 3.25 MOA and 6.5 MOA in size for both LED and Adjustable LED models. MOA dot sizes for Dual Illumination are 7 MOA, 9 MOA and 13 MOA.
- **Triangle or Delta**
The triangle point of aim is an equilateral triangle in 12.9 MOA

Power Source:

- **Battery**
Both LED and Adjustable LED are powered by 2032 Lithium / Manganese Dioxide “Coin” batteries producing 3 volts. The 2032 battery is very common and offered from multiple battery companies.
- **Dual illumination**
Fiber optics and Tritium work in concert to project the reticle; this eliminates the need for a battery.

Housing Materials:

- Forged Aluminum
The RMR body is comprised of forged aluminum with a unique “owl ear” body designed to mitigate and redirect shock away from the glass if dropped. The Dual Illumination RMR bodies house the light collection filter directly above the glass.

Lens Material:

- Tempered glass
Lens glass is both tempered and coated to prevent reflection.

Adjustment:

- Recessed slot screw MOA
Elevation and windage are slot screw adjustable, 1 click per 1 MOA for 150 MOA of total travel

Equipment Implementation

The RMR's relative small size allows for addition to common duty guns, either through attachment to third party mounts or by adding a milled slot for the RMR body to sit deeper in the frame. The short length of the RMR allows the retention of iron sights as a backup sighting system if the optic fails.

Cost advantages of using a third-party mount such as the ALG Six Second Mount, Raven Concealment Baylor or Dueck Defense RBU vary, though they allow a department to mount an MRDS without the need for permanent modification. Duty gear must also be addressed, specifically holsters.

External Mounts



The ALG Six Second Mount has the advantage of allowing the optic to not recoil with the slide, however use precludes the option for back up irons and limits duty holster options. The Six Second mount is also specific to Glock.

The Raven Concealment Balor attaches via the rear sight dovetail, securing the MRDS to the body of the Balor. Back up irons are built into the Balor, though sight radius is severely reduced and iron sight choices limited. Duty holster options are limited.



Dueck Defense's RBU is similar in application to the Raven Concealment Balor; attachment is made via the rear sight dovetail and back up iron sights are included in the mount body. Duty holster options are limited.

Other mount choices besides these are available, however external mounts can be problematic in many ways. For LE purposes, the loss of holster options that provide adequate retention levels may eliminate an external mount as an option. External mounts may also reduce back up sight radius, or prevent them from being used at all.

For the purposes of testing an evaluation at the department level, an external mount is a sound choice, however a purpose milled gun is recommended so that all areas of adaptability, such as holsters, can be considered and evaluated concurrently.

Milled Slide

The best option for duty employment of an MRDS is a milled slide. Slide material is machined via a CNC in order to provide a recessed mounting shoe for the optic body. This option places the optic closer to the traditional height profile officers are used to with iron sights, and allows the use of back up irons; however back up irons must be of suppressor height to clear the optic body. In this configuration, the officer can use either the MRDS reticle or traditional sight alignment/picture to aim based on situation and needs.

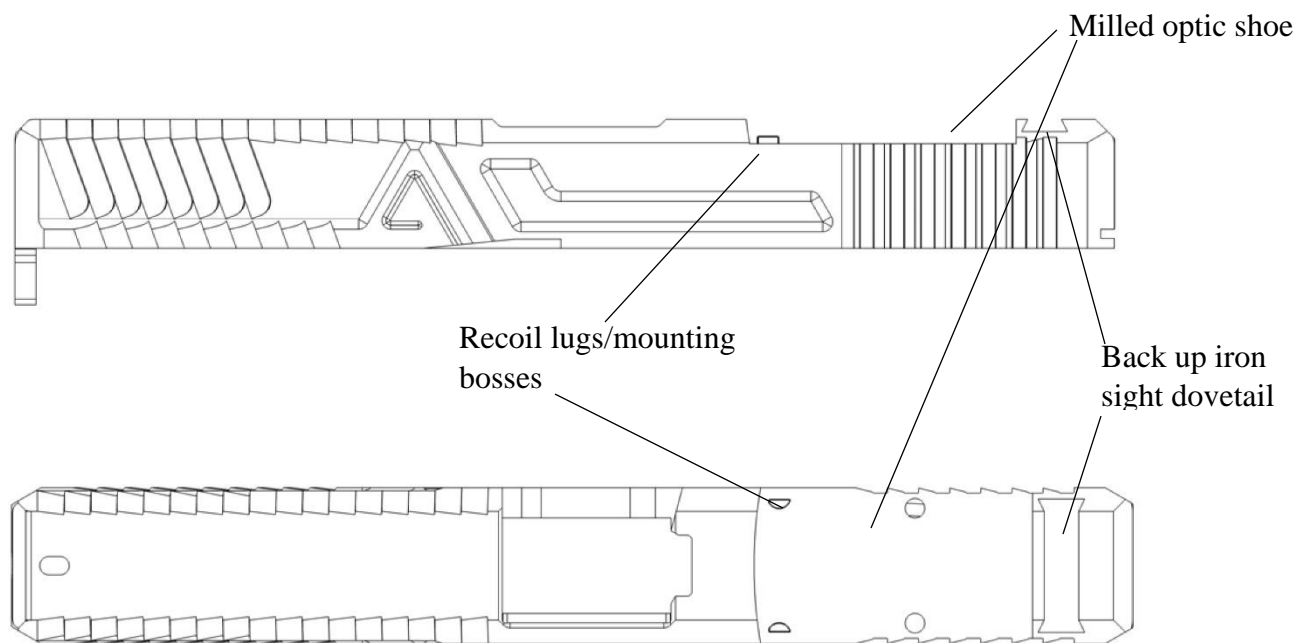

Milling requires a department to provide a third-party shop with duty gun slides, or purchase completed slides from third party machine shops. Due to the growing popularity of MRDS handguns in the market, there are numerous aftermarket options for quality slide work, many have already provided MRDS milling work for LE agencies.

Milled slides also allow duty guns to be used with purpose designed holsters for MRDS handguns from established duty holster makers such as Safariland.

Overall, the single largest advantage of a milled slide is simplicity of additional needed accessories, and a purpose-machined mounting shoe that provides optic-to-slide mounting without additional interface, parts or materials needed. This adds greater stability over external mounts, relatively speaking.

OEM Milled Slides

Some current LE favored manufacturers offer MRDS ready options. OEM Optics Ready handguns are varied in design and adaptability. Every popular LE handgun manufacturer currently offers a proprietary version of an OEM optics platform. The advantage to an OEM system is total warranty support from the manufacturer, however many OEM systems are conservative in their design and may not account for the rigors of LE MRDS use.



Glock Modular Optic System is a factory available variant offered on popular duty models such as the 19, 17 and others. The MOS can mount multiple MRDS makes with changeable boss plates. Due to the boss plate, the optic sits higher on the frame, which may require the use of taller back up iron sights than a direct-to-slide mounting depending on optic choice.

Smith and Wesson M&P CORE is an optics-ready model that, like the Glock MOS, support multiple MRDS options. Also like the MOS, the optic body will sit higher on the frame which make require the use of taller back up sights depending on optic choice.





Sig Sauer P320 X Carry line is a manufacturer offered optics-ready handgun. Various after market adapter options allow mounting of many MRDS optics.

The FN 509 Tactical offers perhaps the best designed and supported OEM optics platform currently offered. Mounting surfaces allow for the optic to be mounted direct to the slide surface, whereas the recoil lugs are changeable to support different model optics.



Modular Milled

A modular milled slide is an after-market option that presents the same advantages of an OEM optics platform, often with a more aggressive approach to optics mounting. Modular milled slides are not married to one specific optic as with a milled footprint, and often provide a greater degree of durability and footprint over current OEM offerings. Two Modular Milled options are recommended:

Unity Tactical ATOM



The Atom is a significant value, even if only used for initial MRDS testing and evaluation in that additional mounting plates allows a department to work through optics under consideration without incurred cost of multiple milled slides. The ATOM also offers quicker support for future optic mounting or department changes in preferred optic.

The Agency Arms Agency Optics System offers a modular platform that can accept all current optics. The AOS mounts from a steel plate and can be purchased in irons-forward or irons-rear configuration. The AOS can also be incorporated into existing Glock MOS models by Agency. For warranty purposes, Agency Arms will honor warranty service and replacement on AOS slides to the same level as Glock.

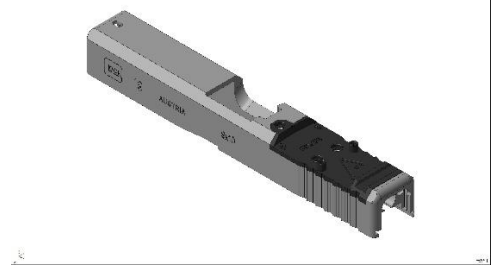

Glock MOS Specific testing: Aftermarket plate systems

Because the Glock family of handguns is easily the most common service weapon in use with law enforcement today, it is expected that departments would choose the MOS optic system as their MRDS host when transitioning to duty optics. The complication with this decision is that the Glock MOS system, specifically the OEM optic mounting plates, are constructed of cheap metal injection molded metal. This makes them needlessly thick and brittle. MOS plates may also be bent or warped from the manufacturer. The thickness of the plate limits the number of threads that mount the plate to the slide, creating a potential failure point. If a plate is bent or warped, this inconsistency, when mounted, will allow the plate to flex against the screw heads during recoil, leading to mounting failure.

Because of this, it is strongly recommended that MOS users do not use OEM MOS plates and instead use an alternative plate. Since 2017, Sage Dynamics has been testing various aftermarket alternatives to the OEM MOS plate for the MOS handgun. That testing data is detailed below.

Make	Testing Period	Round Count	Cause of Failure
C&H Precision Gen 1 DPP plate (Aluminum)	February 2017-	9,850 (est)	Ongoing use
C&H Precision V4 MIL/LEO plate (Aluminum)	June 2020-	5,600 (est)	Ongoing use
Forward Controls Design OPF-G RMR (Steel)	August 2020-	4,250 (est)	Ongoing use

Duty Holsters

Safariland remains the most common duty holster in use by law enforcement today; reliable in its robust weapon retention and intuitive firearm release mechanisms. Safariland offers multiple models of duty holsters for MRDS equipped handguns. Safariland currently offers over a dozen configurations for MRDS handguns in popular duty models.



The 6354 DO model is an ALS release holster, specific to RMR profile optics

The 6362 RDS is an ALS/SLS release holster with optional ALS shroud and an MRDS shield bale.





The 6392 RDS is an ALS only release holster with an optional shroud and MRDS shield bale.

Because holster options for MRDS handguns exist, and those options are provided with similar or the same retention mechanisms that many departments already use, retraining an officer for their duty holster is not an issue if the department chooses to pursue a system that allows the use of holsters such as Safariland RDS models. This is further reason on duty weapon selection that the milled slide is strongly suggested to minimize potential complication with new equipment or forcing a department to source holster options from an unknown quality manufacturer.

During the four-year evaluation period, multiple holsters were tested or observed during courses. Safariland's 6354 DO presented the most reliable and least prone to failure, snagging or complications than other holsters. Safariland's new RDS line of holsters presents with the same quality, however has only been in use for less than six months at the time of this paper so an in-depth opinion wouldn't be prudent.

Optic Care

By adding an optic to the duty handgun, the department and individual officer must accept additional maintenance and care concerns. The MRDS that a department considers should allow for the easiest methods of preventative maintenance at the officer level, and servicing at the armorers or range master level. General care for the optic lens can be performed with a simple micro fiber cloth or q-tip, and lens coating with Rain-X or an anti-fog additive is advised. Even though fogging is not an extreme concern, in some regions its more possible and can easily be prevented with proper lens coating.

Battery life varies from optic to optic. The preferred optic for this paper, the Trijicon RMR, has a battery life of 2-5 years depending on use. It is advisable to replace batteries annually, as the incurred battery cost is minimal and the prevention of battery failure is greatly increased. It is recommended that battery replacement occur during annual qualification.

Optic Durability

Like any piece of duty gear, an MRDS must be able to handle the rigors of law enforcement duty; from the environmental to the incidental, the optic must be as durable as possible to minimize the chances for failure. Historically, law enforcement has been hesitant to adopt new technologies or new ways of thinking regarding training methodologies around those same technologies. In 2017, it is still common to see officers issued patrol rifles without optics, and sometimes without weapon mounted lights, slings or additional ammunition besides what is carried in the firearm. The amount of quality (and often peer reviewed) information regarding reliability and importance of patrol rifle optics or weapon lights is vast and constantly updated with additional information, or refined training methodologies. Much of this training and research takes place outside of individual departments, which means it falls on the responsible department individuals to seek out these sources of information to prevent negative institutional inertia. It is also important that training cadre seek out and work with department officers who may already be subject matter experts on specific equipment or concepts and principles for employment of said equipment.

Throughout the evaluation period, one of the most common concerns from officers trained was; optic durability. Like the initial controversy surrounding rifle RDS, the mounting of an MRDS on a duty handgun was, and is, treated by some as an unacceptable failure point that could lead to an officer losing the ability to aim their firearm when it is needed most. Concerns of reliability are not only proper, but should be continual, so long as they are in context to actual knowledge of potential failure points of MRDS.

Because multiple MRDS were evaluated during the testing period, and some of these MRDS brands did in fact fail, this section is intended to help guide departments away from poor quality options that might otherwise be appealing because of their relative low cost when compared to other optics.

This information is not complete, as testing will continue and it is difficult to pool a large sample size of each brand for concurrent testing without independent funding. As this white paper is intended to be as independent as possible, no outside funding was sought.

Evaluated MRDS

Detailed below are the models and specific data of MRDS evaluated during the four-year period.

Evaluation criteria was realistic use requiring the optic to pass a number of specific, periodic tests as well as continue to function under normal use.

Specific testing:

- Drop testing
Optic dropped while mounted to handgun, optic directed towards deck for drop, from shoulder height. Drop test performed every 500 rounds beginning at 0 rounds.

- Impact testing
Optic used as manipulation device against objects to cycle handgun slide during malfunction drills and one-hand-only operation of handgun. Impact testing on going during evaluation.
- Environmental testing
Optic frozen at 30-28F for 24 hours, heated at 150F for 24 hours. Optic submerged in 12” of ambient temperature water for one hour. Environmental testing performed every 500 rounds beginning at 0 rounds.
- Round count
General target ammunition of 115 and 124 grain 9mm for 500 rounds, with 100 rounds of duty ammunition 124 gr +P, repeating until failure or end of evaluation.

Make, Model and Platform	Testing Period	Round Count	Cause of Failure
Burris Fastfire II 4 MOA dot, Dovetail mount on Glock 17	Feb 2013-Feb 2013	200	Loss of zero during fire, adjustments failure. Not user serviceable.
Burris Fastfire II 4 MOA dot, Dovetail mount on Glock 17	March 2013-June 2013	1000	Electronics. Optic died during second drop test. Not user serviceable.
Burris Fastfire III 3 MOA dot, Mounted on Glock 17 MOS	September 2017-September 2017	500	Loss of optic glass on first drop test. Not user serviceable.
JP Enterprises J-Point 4 MOA dot, Dovetail mount on Glock 19	Feb 2013-June 2013	325 (est)	Loss of zero during fire, adjustments failure. Not user serviceable.
JP Enterprises J-Point 4 MOA dot, Dovetail mount on Glock 19	July 2013-January 2014	3,000	Loss of zero during drop test, adjustments failure. Not user serviceable.
Trijicon RMR RM01 3.5 MOA dot, milled mount on Glock 17	April 2013-October 2013	1,800 (est)	Electronic failure during fire, optic died. Not user serviceable.
Trijicon RMR RM01 3.5 MOA dot, milled mount on Glock 17 (type 1)	November 2013-December 2020	12,200	Battery connection failure. Not user serviceable.
Trijicon RMR RM07 6.5 MOA dot, Milled mount on Glock 17 (type 1)	December 2014-	16,100	No Failures
Insight MRDS 3.5 MOA Dot, Dovetail mount Glock 17	March 2014-December 2014	2,176	Battery connections broken during fire. Not user serviceable.

Docter Sight II 3.5 MOA dot, Dovetail mount on Glock 17	March 2014-August 2014	2,000	Optic lens broken during drop test. Not user serviceable.
Trijicon RMR RM07 6.5 (type 1) MOA dot, Milled mount on UTM slide.	May 2014-	8,100 (UOF ammo only)	No failures
C-More STS 7 MOA dot, dovetail mounted on Glock 19	December 2014-December 2014	800 (est)	Battery connections broken during manipulation/fire. Not user serviceable.
Vortex Venom 3 MOA dot, dovetail mount on Glock 17	February 2015-May 2015	1,020	Electronics failure during fire, optic died. Not user serviceable.
Trijicon RMR RM07 6.5 MOA dot, Milled mount on Glock 17 (type 1)	June 2015-Jan 2016	4,150 (est)	Battery connections broken. Not user serviceable.
Trijicon RMR RM06 Type 2 3.25 MOA dot, Milled mount on Glock 17	June 2017-	31,470	No failures.
Leupold Delta Point Pro 2.5 MOA dot, Mounted on Glock 17 MOS	April 2018-April 2018	1,500	Optic glass broken. Not user serviceable.
Leupold Delta Point Pro 2.5 MOA dot, Mounted on Glock 17 MOS	April 2018-March 2019	4,200	Optic glass broken. Not user serviceable.
Leupold Delta Point Pro 2.5 MOA dot, Mounted on Glock 17 MOS	April 2018-June 2018	2,900 (est)	Battery connection failure. Not user serviceable.
Leupold Delta Point Pro 2.5 MOA dot, Mounted on Glock 19 MOS	June 2018- August 2018	4,100 (est)	Battery connection failure. Not user serviceable.
Leupold Delta Point Pro 2.5 MOA dot, Mounted on Glock 19 MOS	December 2018-February 2019	5,113	Emitter failure. Not user serviceable.
Sig Romeo 1 3 MOA dot, mounted on Glock 17 MOS	July 2018-July 2018	524	Optic glass broken on drop test. Not user serviceable.
Vortex Viper 6 MOA dot, mounted on Glock 17 MOS	July 2018-July2018	1,500	Optic glass broken on drop test. Not user Serviceable
Holosun 507C 2 MOA dot/ 35MOA ring reticle, milled mount Glock 17	September 2018-	10,100	Glass cracked remains zeroed
Trijicon RM09 type 2 1 MOA dot, Agency AOS mounted	December 2018-	5,800	No failures.
Trijicon RM09 type 2 1 MOA dot, Agency AOS mounted	January 2020-June 2020	4,800	Elevation adjustment failure. not user serviceable.

Holosun 508T	August 2019-	4,625	No Failures
Holosun 509T	December 2019-	13,220	No Failures
Holosun 508T V2	March 2020-	8,950	No Failures
Holosun 508T V2	June 2020-	1,200	No Failures
Aimpoint ACRO	April 2019-	11,520	Outer lens broken, inner lens cracked. Holds zero, still functional.
Sig Romeo 1 Pro (with OEM shroud) 3 MOA	December 2020-December 2020	1,025	Optic glass broken during second drop test, not user serviceable.
Browe Micro Reflex	January 2021-January 2021	525	Optic glass broken during first drop test. Not user serviceable.
Swampfox Justice	December 2020-	1,128	Optic glass has multiple cracks, shroud deformed. Still functional.
Grace Optics M1	March 2021-March 2021	500	Lens ejected from housing on first drop test. Not user serviceable.

While testing continues on functional MRDS, the two manufacturers that continue to provide reliable service are the Trijicon RMR, the Holosun 507/508/509 and Aimpoint ACRO.

It is worth noting that multiple battery failures occurred during testing on multiple MRDS, however all noted battery failures were with Energizer and Sony brand batteries and each failure was well before the quoted battery life of the optic they were mounted in. Duracell brand batteries have only failed when charge was exhausted to date.

Some alternative MRDS options require manual on/off operation. The need to turn a handgun MRDS on manually should exclude any model from consideration, considering constant-on options with extensive battery life exist.

This is not an exhaustive list of available brands or models of available MRDS and should be treated as anecdotal information since, while every effort was made to adhere to criteria, ammunition variances over time prevent the testing from being as scientific as it could have been under an accelerated testing period with dedicated and controlled ammunition by lot and all MRDS tested concurrently.

Line of Duty Optics Failures

Beginning in 2018, Sage Dynamics began tracking self-reporting data of MRDS failures in the line of duty. While the MRDS is being widely adopted and authorized for LE duty carry, Sage Dynamics is only able to collect reliable accounts from graduates of the Sage Dynamics RDS Handgun Instructor course and their students, or graduates of the RDS Defensive Handgun course. This data, though

reliable, should not be considered exhaustive. Using a standardized form, Sage Dynamics course graduates can detail optics failures occurring with RDS carried on duty in any capacity. This section, as with ongoing testing, will be updated periodically with future updates.

It is important to note that as of the 2021 update, this information covers over 600 RDS Handgun Instructor graduates and the officers trained by them, with a possible sample size of 10,000+ RDS handguns in use on duty. Additionally, reported numbers are derivative of popular optics in use, the Trijicon RMR remains the most commonly issued/authorized MRDS for LE use.

Optic	Failure	Occurrences
Trijicon RMR Type 2 RM06	Emitter window failure (window adhesive fails)	21
Trijicon RMR Type 2 RM06	Windage/elevation failure (optic cannot maintain zero)	15
Trijicon RMR Type 2 RM06	Emitter window cracked	2
Trijicon Type 1 RMR RM02	Windage/elevation failure (optic cannot maintain zero)	2
Trijicon Type 1 RMR RM06	Windage/elevation failure (optic cannot maintain zero)	1
Trijicon SRO (various MOA)	Optic lens broken-crush force while holstered during an arrest	3
Trijicon SRO (various MOA)	Optic lens broken-drop	1
Holosun 508T (v1)	Electronics failure-auto brightness-reticle not useable in direct sunlight	2
Holosun 507C (V1)	Electronics failure-auto brightness-reticle not usable in direct sunlight	1
Holosun 507C (V1)	Optic lens broken-crush force while holstered during an arrest	2
Leupold Delta Point Pro (various MOA)	Power failure-not battery related	16
Leupold Delta Point Pro (various MOA)	Optic lens broken-crush force while holstered during arrest	8
Leupold Delta Point Pro (Various MOA)	Windage/elevation failure (optic cannot maintain zero)	4
Sig Romeo 1 Pro	Power failure-not battery related	3
Sig Romeo 1 Pro	Windage/elevation failure (optics cannot maintain zero)	2
Sig Romeo 1 Pro	Optic lens broken-crush force while holstered during arrest	3

Optic	Failure	Occurrences
Sig Romeo 1 Pro	Optic lens broken-drop	2
Aimpoint ACRO P1	Power failure-not battery related	2
Aimpoint ACRO P1	Windage/elevation failure (optic cannot maintain zero)	1
Vortex Venom (3 MOA)	Power failure-not battery related	2
Vortex Venom (3 MOA)	Windage/elevation failure (optic cannot maintain zero)	4
Vortex Venom (3 MOA)	Optic lens broken-crush force while holstered during an arrest	3

Visual and Mental Complications During a Use of Force

The complicated nature of a use of force is one of the most researched subjects in law enforcement. Factual scientific analysis of an actual use of force is difficult as an officer's use of force in the moment cannot occur under proper scientific controls and one event to the next presents insurmountable inconsistencies that result in far more anecdotal information. This section will detail the biological processes and difficulties involved in the use of a sighting system in a use of force.

Considering the history of armed conflict, the firearm is the first tool in which the user was required to direct their focus to the tool and not to the threat; *front sight focus* is the correct mantra for proper fundamental accuracy. Be it rifle, shotgun or handgun, the officer must focus their attention, their vision, on the front sight of the firearm. This presents a few issues once we look at physiology under stress, and potential liability regarding at-the-moment use of force against a clear and present threat.

These two issues, above all others, must be explored in-depth to best make an informed decision on optics for duty use.

Human Vision Under Stress

In 1851, Hermann von Helmholtz published *Handbuch der Physiologischen Optik* (Handbook of Physiological Optics)³. This work was one of, if not the first, scientific looks at how the human eye behaves under stress. Helmholtz conducted extensive research and was able to lay out the beginning of understanding to what would evolve into the common psychophysiological occurrence of *fight or flight*. Even though Helmholtz's mission was to understand the eye's behavior in general, he noted that stress in the body had a high likelihood of causing involuntary reactions such as loss of near focus.

Independent from Helmholtz's research, Dr. Walter Cannon published the research that would lead to the common foundational understanding of *fight or flight*.⁴ Dr. Cannon's studies noted the body's reaction to threat stimulus; the involuntary responses that caused the body to release a number of hormones and neural signals to prepare the body for attack, defense or fleeing the danger stimuli. This General Adaptation Syndrome⁵ causes a number of measurable changes in the body that effect performance, reasoning and vision. The severity of these effects is dependent on training, experience, known information and physical condition.

Stress as an occurrence is a direct result of actual or perceived stimulus that forces the body to regulate its functions, or divert attention to critically needed functions while generating a solution to remove the stress and return to homeostasis. Until the 1930's⁶, the word *stress* was not part of the scientific lexicon and despite research before then, the focus of understanding was more academic. Research into the Autonomic Nervous System (ANS), more pointedly the Sympathetic Nervous System (SNS), a branch

³ [Handbuch der Physiologischen Optik](#) (Handbook of Physiological Optics), Hermann von Helmholtz (1851) Translated by James P. C. Southall, Optical Society of America (1924)

⁴ [The Wisdom of the Body](#) (1932), [Bodily Changes in Pain, Hunger, Fear and Rage](#) Dr. Walter Cannon (1915)

⁵ [Health Psychology 2nd Canadian Edition](#) Taylor, Shelley, and Sirois, Fuschia. (2012)

⁶ [Putting Stress in Life: Hans Selye and the Making of Stress Theory](#). Social Studies of Science. R. Viner (1999)

of the ANS, has provided continual breakthroughs in our understanding of the bodies behavior during a use of force.

Modern research into the ANS is arguably thanks to the pioneering work of Dr. John Newport Langley. His publication on the Autonomic Nervous System⁷ paved the way for collective research into what we have come to colloquially refer to as our *body alarm* or *fight or flight system*. The Sympathetic Nervous System serves one active purpose, to stimulate and regulate our responses to a threat stimulus. When threat stimulus is processed by the senses, the SNS goes from a mostly dormant state of assisting in homeostasis⁸ to actively altering the bodies status by priming the body for action. Many changes occur in a short period of time when the SNS is active, and the degree at which these changes effect performance (or the specific functionality of the specific area/organ/function) is dependent on a number of contextual and training factors.

SNS effects on the body

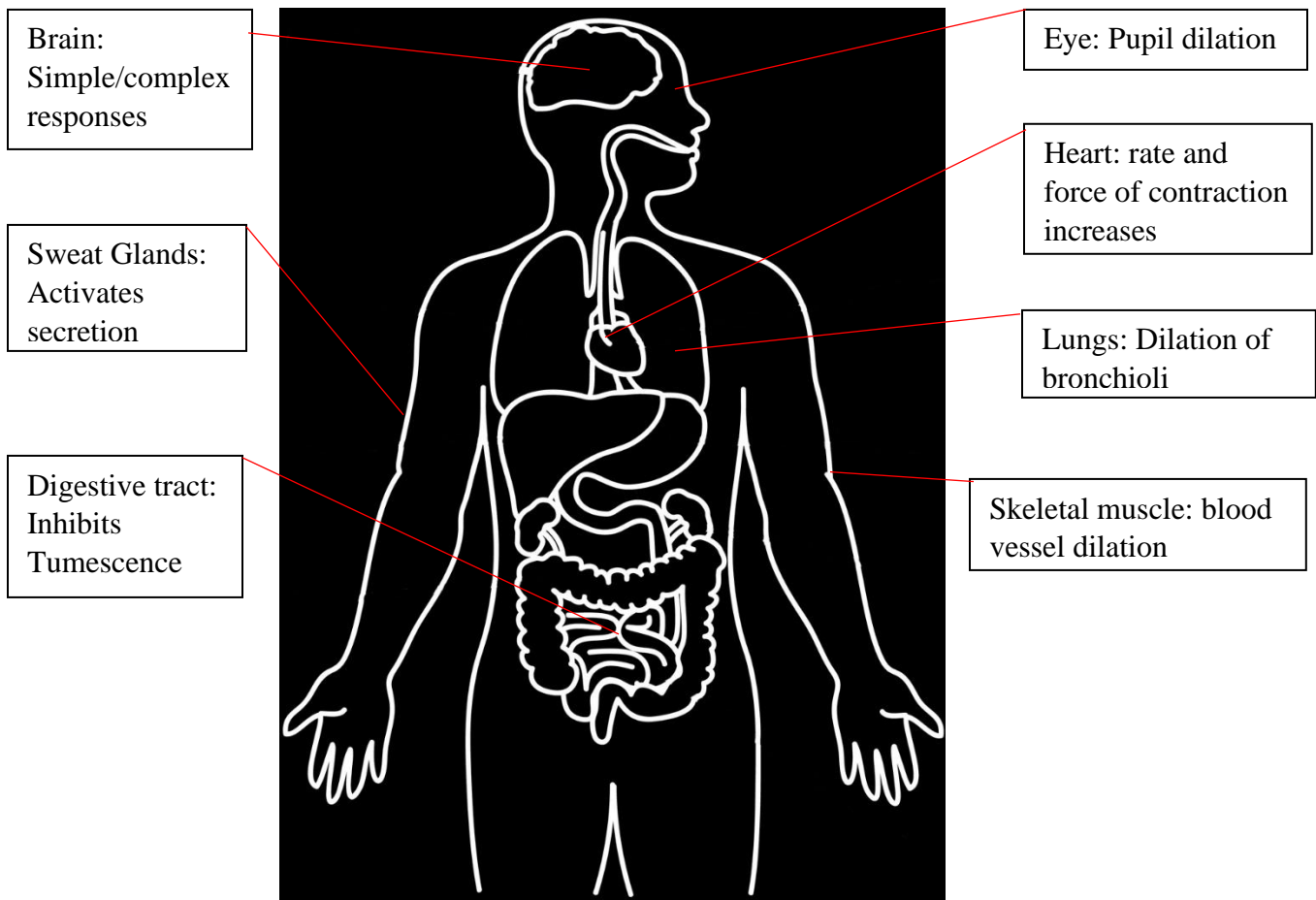

⁷ The Autonomic Nervous System, Dr. John Langley (1921)

⁸ The Central Nervous System: Structure and Function, Per Brodal (2004)

Many complex, and simple bodily actions take place in a very short period of time once the senses have processed a threat stimulus. The nature and the quality of information an officer receives largely will determine the intensity of the SNS response. As a complex topic, we are focusing strictly on the human eye and the SNS and mental processes that directly effect it in relation to an officer's ability to see and more importantly, process what is being seen. Before we look at the eye, which is the main focus of this section, it is important to talk first about how the brain's processing under stress effects eye performance and processing of information.

An officers primary source of information for the use of force comes from the eye. Input from other senses, such as hearing, may aid in the decision to use force, but without quality input from the eye, judgement, justification and accuracy can be severely hindered or prevented in totality.

When a stimulus is detected by the senses, one of two general processes will occur, and which process is largely determined by the proximity of the stimulus, and how long the stimulus was observed before it was recognized as a threat.

If the recognition of the stimulus is sudden, a startle reaction, or *Somatic Reflex* can occur. Startle Reaction is a refractory reaction that does not require conscious thought and can occur in as little as 50 milliseconds, usually ending after 500 milliseconds⁹. When a threat (stimulus) is apparent, information is routed to the Thalamus in the brain, which will then distribute it to the appropriate areas of the brain, the amygdala, visual cortex and frontal lobe. In close proximity, this may result in a precognitive startle, in which case the information is directed to the amygdala, bypassing the "thinking" brain where access to learned information occurs¹⁰. The amygdala activates protective reflexes, however there is no standard startle reaction; in fact, there are more than 30 possible startle reactions¹¹ that are greatly determined by the overall nature of the information received initially by the brain. This is known as *Low Road Processing*.

Dr. Joseph LeDoux's research¹² mapped *High Road* and *Low Road* processing, detailing how our brain will sort information based on the totality of the situation and the time available to process the situation.

Under Low Road processing, the perceived stimulus is downloaded by the thalamus and then sent directly to the amygdala, which generates a protective startle. The amygdala activates our Sympathetic Nervous System; a startle reaction takes place and only then is the stimulus information sent to the appropriate cortex where conscious processing can occur, namely, jumping into the High Road.

The High Road is where the stimulus is Observed, information is routed to the thalamus by our senses and processing begins as that information is routed to the appropriate cortex (most likely visual). The processed information is then downloaded to the amygdala and a reaction/response is generated in the

⁹ Amygdala and Anterior Cingulate Cortex Activation During Affective Startle Modulation: a PET Study of Fear, Anna Pissiota (2003)

¹⁰ Differential Contribution of Amygdala and Hippocampus to Cued and Contextual Fear Conditioning, R. Phillips (1992) The Role of the Amygdala in Fear and Panic, Doug Holt (2008) The Role of the Amygdala in Fear and Anxiety, Michael Davis (1992)

¹¹ Boo! Culture, Experience, and the Startle Reflex, Ronald Simmons (1996)

¹² The Emotional Brain Joseph LeDoux (1996)

form of a response along with the generation of emotion and fear. High Road is where training, technique and competency in both play the largest part. It is creating reactions where unconscious actions may occur, but they are trained unconscious actions built to a level of competency by repetition.

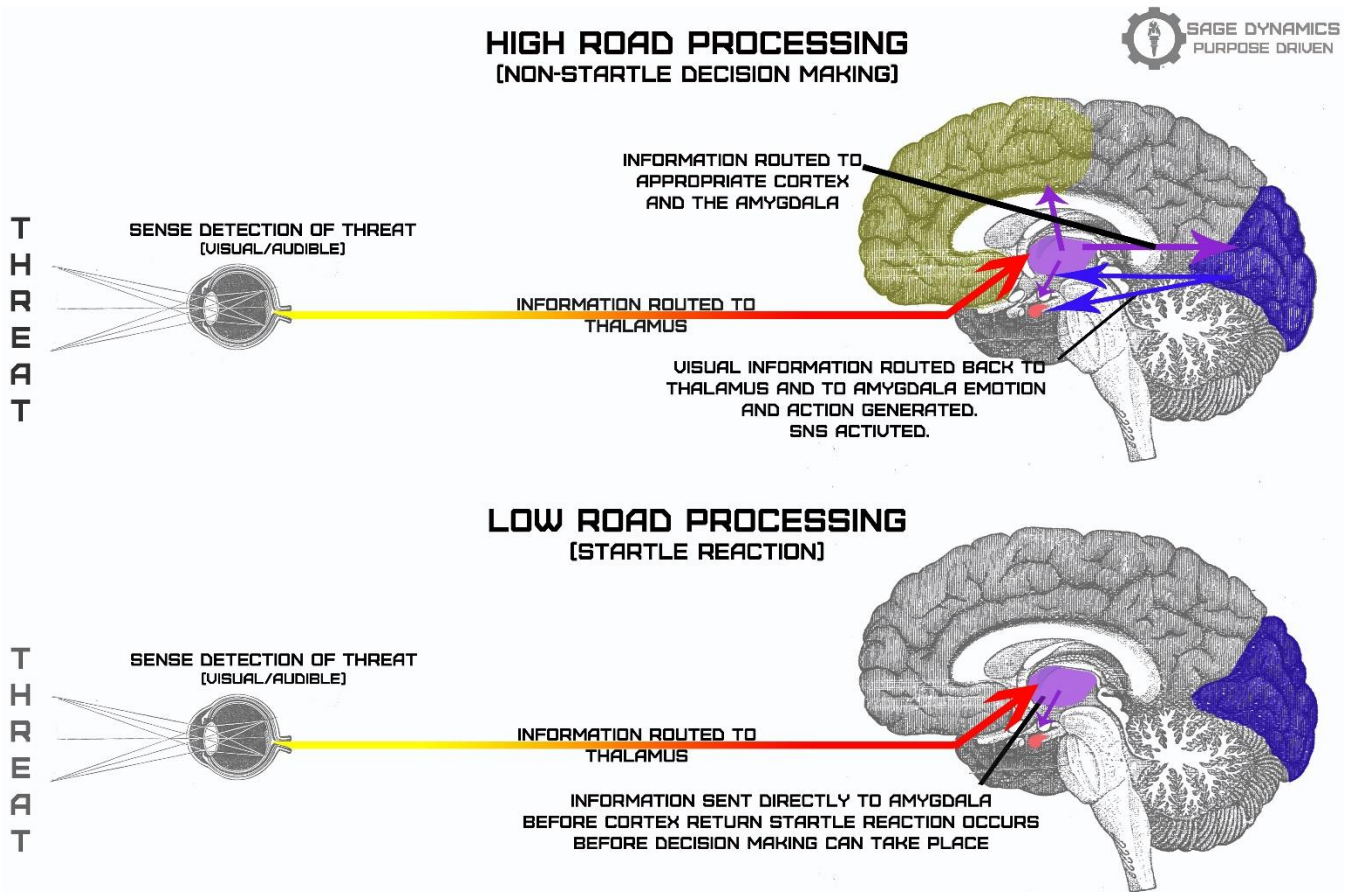

In either process, though more notably under Low Road processing, the SNS activation and startle reaction in general cause involuntary changes in the eye.

The human eye is a very complex piece of natural engineering; it can alter point of focus from near to exceedingly far distances through accommodation¹³ at speeds between 350 milliseconds and 1 second¹⁴ depending on age and general eye health (as well as environmental conditions). But this ability is highly dependent on the levels of stress in the body. The SNS activation occurs as the threat stimulus is recognized, and this means that the hormones released by SNS activation will affect the eye, however before the hormonal effects can even reach the eye, the pupil is dilated by SNS which complicates vision. Further complications are how SNS *and* adrenaline effect the muscles of the eye, specifically the ciliary muscles and fibers.

¹³ Accommodation-dependent model of the human eye with aspherics, R. Navarro, J. Santamaria and J. Bescos (1985), The eye in focus: accommodation and presbyopia, Dr. W Neil (1998)

¹⁴ Eye movements and perception: A selective review, Alexander C. Schütz, Doris I. Braun, Karl R. Gegenfurtner, Journal of Vision (2011)

It's also important to understand that the amygdala is critical to the neural process under SNS¹⁵, and it has been shown that the amygdala is directly linked to fear and fear memory, which can directly correlate to method of aiming and training procedures for marksmanship.

The Ciliary muscles are a ring of muscles that surround the lens of the eye. They contract or relax to change the shape (thickness) of the lens to alter desired focal distances, this is Accommodation.

Under stress, the Ciliary muscles are directly affected by adrenaline, which takes time to reach them, however the SNS effects can be instantaneous¹⁶, they contract, which thickens the lens for distant focus, literally eliminating the possibility for near focus under these conditions, they affect normally voluntary systems, in this case, focal point¹⁷.

The involuntary loss of control over the Ciliary muscles when we react to a threat is programmed into our “fight or flight” response. Our field of vision is increased to its maximum, the pupil dilates to allow in the maximum amount of light and allow us to best see our threat. Speaking in historical terms, we have been fighting with our hands and hand weapons much longer than firearms.

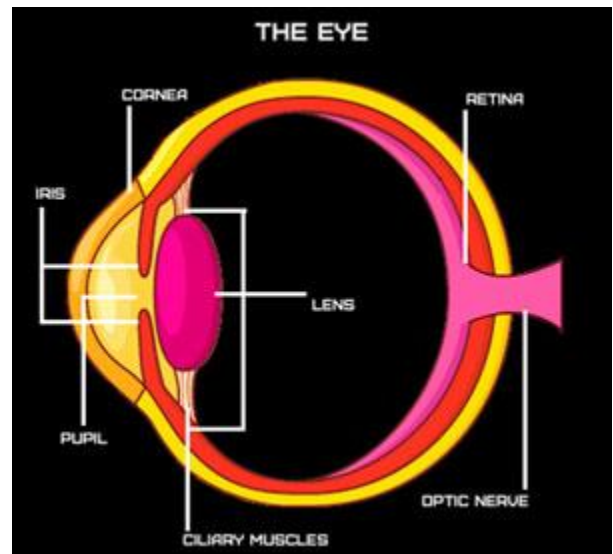

¹⁵ Interplay of Amygdala and Cingulate Plasticity in Emotional Fear, Neural Plasticity Volume 2011 (2011)

¹⁶ Formation of the aqueous humor, Dr. Janet Fitzakerley, University of Minnesota Medical School (2014) Adler's Physiology of the Eye: Expert Consult 11th edition, Leonard A Levin, Siv F. E. Nilsson, James Ver Hoeve, Samuel Wu, Paul L. Kaufman, Albert Alm (2011)

¹⁷ Autonomic Nervous System, Flinders University, Australia Dr. Bill Blessing, Dr. Ian Gibbins (2011), The Integrative Action of the Autonomic Nervous System: Neurobiology of Homeostasis, Dr. W.W. Jänig, Cambridge University (2006)

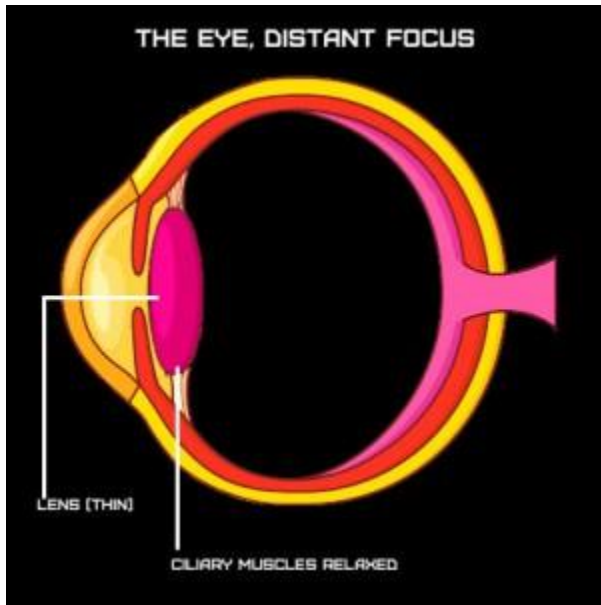

With implicit hand-eye coordination developed since birth, our threat response is hard wired to focus on the threat. Motor control for hand movements is not dependent on continual visual input. Unfortunately, visual input, close focus, is necessary for sighted fire with a firearm. Sighted fire is done by centering the front sight in the rear notch, placing the front sight in focus and driving it to a spot over our threat. When the SNS activates, this ability is largely lost. The “front sight focus” that has been beaten into every shooter’s brain from day one is gone; we cannot focus on the front sight because our nervous system doesn’t allow it. Loss of near focus is temporary, though appears to last as long as the SNS is active or a conscious decision is made to alter the point of focus.

Tunnel vision (visual perceptual narrowing) is another reaction to an SNS activation when a threat is perceived and is also common in high stress situations that do not involve threat of injury¹⁸. When the SNS activates, in addition to adrenaline being released into the body, Cortisol is also released. Cortisol effects perceptual error detection¹⁹ literally blocking visual input from being processed by the visual cortex²⁰. It’s not that the information isn’t *seen*, it’s that the information is not regarded as important and therefore not given the same attention as that in the direct field of vision.

These occurrences may be momentary, or they may last for seconds, minutes or longer. The research into vision under stress with a focus on law enforcement is not nearly expansive or in-depth enough to offer concrete timeframes for ocular symptoms of stress, but what is known is that they occur, and their negative effects on the traditional use of iron sight shooting should be plainly obvious. If you lose the ability for near sight focus, even for a fraction of a second, you lose the ability to focus on your front sight.

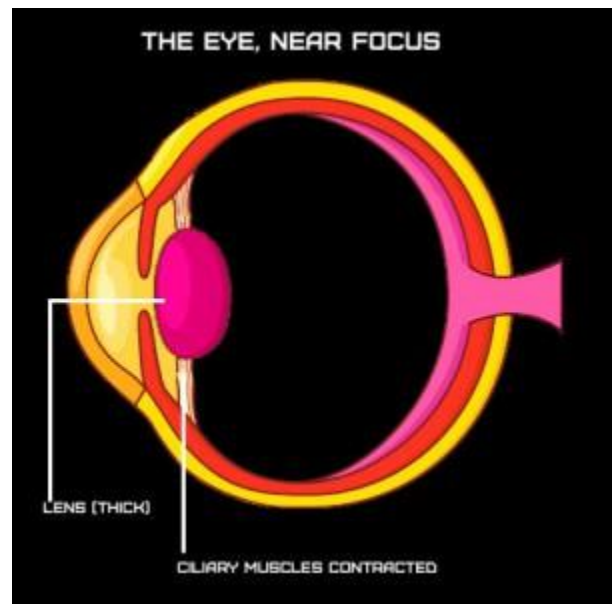

¹⁸ World Health Organization. Work with visual display terminals: Psychosocial aspects and health. J Occup Med (1989) Situational Awareness Matters Dr. Rich Gasaway

¹⁹ Effects of a single dose of cortisol on the neural correlates of episodic memory and error processing in healthy volunteers. Psychopharmacology ,FC Hsu, MJ Garside, AE Massey, RH McAlister-Williams (2003)

²⁰ Tunnel Vision. Its Causes, Treatments and Strategies, Edward C. Godnig, O.D. (2003)

It is important to note that under High Road processing, a situation where an officer has already moved through Low Road processing, (or it never occurred due to the specifics of the encounter) it is entirely possible and common for an officer's vision to not suffer such extreme effects. Under a judgement situation where an officer is issuing verbal commands or otherwise holding a suspect at gun point, near focus can return or never be lost to begin with due to the lack of the somatic reflex to a threat, extensive stress inoculation training, or focal point return based on the amount of time that has elapsed.

Further evidence to visual complications can be seen in LE force on force exercises. An invaluable tool for law enforcement when used properly, force on force systems such as UTM or Simunitions FX allow trainers to provide students with a very realistic training experience; that is to say that participants will experience an SNS activation and the symptoms that come with it. Because this is as close as we trainers can get to having environmental control over a use of force, the data that can be gathered in training exercises can and should be used to shape policy and pursue technology to aid in more effective officers. From 2011 to 2014, Sage Dynamics conducted a study of students during force on force training courses.

Sage developed a few very simple questions that would ask at the end of an officers training scenario. These questions were asked of each student in a handgun scenario immediately following a logical conclusion of their training. As the scenarios spanned three years and covered a number of varied training specifics such as close quarters shooting, low light, active shooter response, vehicle defensive skills, felony stop procedures, etc. The information is anecdotal, though telling as the type of training is varied yet the commonalities between students is obvious. All scenarios polled placed the threat(s) within 15 feet of the student at the scenario beginning. Any scenario conducted during this time that began with a threat at a greater distance was omitted. 110 Students over three years were polled.

Three direct questions were asked to poll information.

Three simple questions.

Were you able to acquire a gross or fine sight picture under a spontaneous threat?

- No: 90%
- I don't remember: 9%
- Yes: 1%

Were you able to consciously focus and find your sights?

- I didn't have time: 33%
- No: 31%
- Yes: 23%
- I don't remember: 13%

Did you unconsciously acquire a sight picture at some point during the scenario?

- No: 65%
- Yes: 20%
- I don't remember: 15%

Handguns used during the study:

- Beretta 92
- Glock 17

Sights used:

- OEM Beretta
- OEM Glock
- Glock Night Sights
- Truglo TFO
- XS Big dot
- Trijicon NS
- Trijicon HD
- Dawson Precision (fiber optic front)

Student shooting experience:

- 0-5 years: 20
- 6-10 years: 45
- 11-20 years: 28
- 21+ years: 17

The length of a scenario, and how fast an officer was forced to react was largely responsible for the ability or inability to eventually acquire a conscious sight picture. Students that were placed in a sudden shoot situation when the reaction-time-to-rounds-fired time frame was mere seconds almost exclusively answered in the negative. Scenarios that gave the student a greater distance from the threat or allowed them to move to cover, or fight from cover allowed some students to acquire a sight picture after those first few seconds had passed, their threat moved and they perused, or the situation called for more precise fire (such as the threat using cover). This information is by no means complete, nor was it gathered under a specific set of like scenarios to ensure commonality of data. It was collected from varied scenarios from students with varied back grounds on purpose. Instead of establishing the facts within a narrow scope, Sage Dynamics wanted data from the widest possible number of circumstances

because reality continues to show us time and time again that each gunfight is unique in many ways and the only commonality is often in our involuntary reactions to stress.

Mental Processing Under Stress

Additional problems with vision may present given officer information, or lack thereof, especially in environments where lighting is reduced or must be produced by flashlight. Mistake-of-Fact shootings can occasionally be explained by mental processes usually attributed to safe assumptions made by an officer, however the reality is more complex.

Everyone has had at least one experience in which they saw something out of the center of their vision, or in a reduced light environment, or hidden in the grass or foliage in which they assumed it was something that it turned out not to be. A coat rack appeared to be a person, a stick in the grass appeared to be a snake. A cellular phone appeared to be a gun. When limited information is available to the senses, the senses may attempt to fill in missing details. This is the partly due to Amodal Completion²¹. Our mind groups objects together as a whole, even if they are not, so long as they seem to complete a pattern or object, or a general shape or color contrast is assumed to be something it may or may not be before the viewer can, or has time to gather additional visual input. A *Cognitive Interpolation* is perhaps a more reliable term as it describes a specific function of the mind to add missing information based on prior experiences, training or previously seen information. The mind will use Heuristics²² to solve problems as they are occurring, even if they are not the ideal process to gather data, based on any real or perceived need immediate data. Heuristics are based on previous experience or training, and may have advantages or disadvantages based on that previous experience or training. While a Heuristic is a proven method for problem solving (and largely unavoidable mental process)²³ they are susceptible to cognitive bias, stereotypes and bad training²⁴. Tom Aveni's study²⁵ on behalf of The Police Policy Studies Council found a high number of mistake of fact shootings from multiple departments, in the 18%-33% range. More to the point, Aveni's research found that; "*Low light shootings account for at least 60% of police applications of deadly force. They seem to diminish police hit ratios by as much as 30%. Low light also accounts for as many as 75% of all mistake-of-fact shootings.*" Training may be partly responsible for a mistake-of-fact shooting, but Heuristics drives the mistake. If an officer must judge a potential use of force under expected stress, the more visual input they can get, the better a decision they are able to make.

A mistake-of-fact shooting is just that, an honest mistake made by an officer in a small fraction of time when the need for lethal force was believed to be justified. Aveni's study is imperfect in that it cannot account for a large number of agencies, only 5 major metropolitan agencies provided officer involved

²¹ Amodal Completion, Perception and Visual Imagery, Clotilde Calabi, Interpolation and extrapolation in human behavior and neural networks, J Cogn Neurosci. (2004)

²² Heuristics, servants to intuition, in clinical decision making, Jane Cioffi (1997)

²³ Use of heuristics: Insights from forecasting research. Thinking & Reasoning N. Harvey (2006), Heuristics: Tools for an uncertain world". Emerging Trends in the Social and Behavioral Sciences, Hansjörg Neth (2015)

²⁴ How to Make Cognitive Illusions Disappear: Beyond "Heuristics and Biases" Gerd Gigerenzer (1991)

²⁵ Officer-Involved Shootings: What We Didn't Know Has Hurt Us. Thomas J. Aveni, M.S. (2003)

shooting data, and the method of collection (and detail of data) varied between the 5. This means that data collection by individual agencies needs to be as specific as possible and must be shared with other agencies and trainers to aid in reduction of MOF shootings and an overall increase in training quality to better empower officers if the need for force arises.

In law enforcement, a great deal of training is focused on mental processing, decision making and judgement shooting. Despite this, we regularly hear of, and see evidence of, police hit percentages being very low. A 2006 Rand study of the NYPD found that officers maintained an 18% hit ratio in exchanges of gunfire with suspects, and a slightly higher 30% hit ratio when suspects were not actively engaging them with gunfire²⁶. A national average on hit percentages is not available, though anecdotal numbers quoted rarely appear above 20%.

Force Science studied police academy graduate accuracy against the accuracy of novice shooters with little or no formal training or experience. The study found that Expert officers had no significant advantage over intermediate shooters and only a small advantage over novice shooters²⁷. This should be troubling information for law enforcement trainers; no matter the quality of training, we must avoid the institutional inertia of continuing to do what provides scored success when the qualification is a policy standard, it is not the standard an officer will be measured by in a use of force.

The reasons for these percentages are as much about training as they are about the unknown quantity; you cannot predict the situation in which force will be needed, but you can best prepare officers for the situation if it arises. This preparation is about more knowledgeable understanding of force, its effects on the body and their effects on equipment use, and a better approach to embracing technology that will allow officers to more effectively confront a use of force.

Sights in Reduced Lighting

Law Enforcement is a 24 hour a day operation; which generally goes without saying but it's important to mention it specifically in regard to an officer's ability to acquire their sighting system regardless of the conditions present when they need to do so. Besides natural darkness, buildings, structures and vegetation may artificially create lighting conditions that are not favorable to accurate identification of potential or known threats, or the ability for an officer to focus on and align their sights.

²⁶ Evaluation of the New York City Police Department Firearm Training and Firearm-Discharge Review Process, Bernard D. Rostker, Lawrence M. Hanser, William M. Hix, Carl Jensen, Andrew R. Morral, Greg Ridgeway, Terry L. Schell, RAND (2006)

²⁷ The real risks during deadly police shootouts: Accuracy of the naive shooter, Force Science, William J Lewinski (2015)

Humans are diurnal by nature. The human eye is not capable of low light acuity. In nature, many mammals possess a *tapetum lucidum*, a biological reflector that reflects entering light back towards light sensitive retinal cells after it has entered their eyes to give the cells a second chance at stimulation, greatly increasing natural night vision. This is why many animal's eyes shine in low light when light is directed into them.

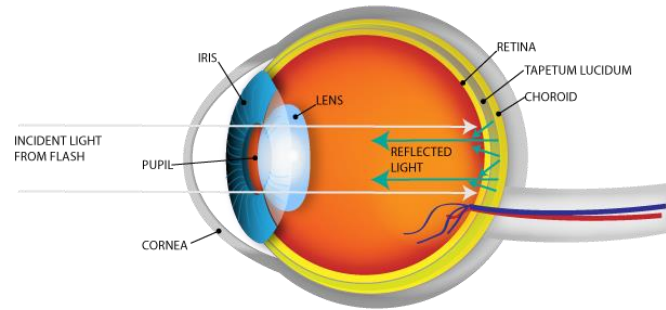

In humans, our eyes are far more adapted at daylight conditions. Rods and cones are the two types of photoreceptors in the retina responsible for the transmission of images to the brain. Since we lack a tapetum lucidum, the light entering the eye has only one chance to charge these photoreceptors, our receptive field is determined by this. Contrary to commonly held belief, rods and cones have a very similar receptibility to light, both will respond to a single quantum of light, but rods will produce a bigger response²⁸.

In natural day light; *Photopic light* the human eye processes light mainly via the cone cells, the visual system throws light away, creating *lateral inhibition*, edge-sharpening that actually decreases neural activity in response to light²⁹. The effect is similar to the edge-sharpening function on a computer graphics program. This gives the human eye an amazing ability to detect movement, differentiate color, accommodate focal distances and reconcile edges, even with low contrast objects, but this comes at a cost, as already mentioned.

In *mesopic light*, or *twilight*, the lighting conditions commonly associated with dawn/dusk, the eye begins to lose its photopic advantages, color differentiation, focal accommodation, and edge detection become problematic. The eye is confused between photopic and *scotopic* vision. “Scotopic” is darkness, low light created naturally or artificially by conditions in which the eye relies heavily on the cone cells to transmit visual data to the brain. Rod cells occupy the outer edges of the retina, making peripheral vision relatively more reliable, though in scotopic light, the eye loses its ability to determine color or judge depth accurately. When the eye is in full saturation, be it photopic or scotopic light, information processing is continual to those conditions and data confusion.

Light, measured by *lux*, is a helpful, though academic method to measure lighting conditions.

²⁸ [Human Factors, Night Vision](#), Dr. Marc Green

²⁹ [Psychology of Touch and Blindness](#), Heller, Morton A.; Edouard Gentaz (2013)

LUX (1 LUMEN PER SQUARE METER)		
LUX LEVEL	VISION TYPE	EXAMPLE
1,000,000+	PHOTOPIC	FULL SUNLIGHT (BLINDING)
100,000	PHOTOPIC	HAZE, COMFORTABLE
1,000	PHOTOPIC	DIFFUSED, CLOUDY
100	PHOTOPIC	ELECTRIC LIGHTING
10	PHOTOPIC	TWILIGHT
DIURNAL THRESHOLD		
1	MESOPIC	FULL MOON, ACCENT LIGHT
0.1	MESOPIC	HALF MOON, BRAKE LIGHT WASH
0.01	MESOPIC	QUARTER MOON, GUIDE LIGHTING
0.001	SCOTOPIC	FULL STARLIGHT
0.0001	SCOTOPIC	PARTIAL STARLIGHT
0.00001	SCOTOPIC	OVERCAST DARKNESS
0.000001	SCOTOPIC	TOTAL LACK OF LIGHT

For practical purposes, it is very rare for law enforcement to be forced to work in complete scotopic light; urban areas and even semi-rural locations at night produce a great deal of artificial light to create mesopic or even photopic conditions. Inside of buildings, mesopic light is very common and is often the default condition during daylight hours unless lights are turned on. Some structures, such as commercial warehouses or factories, storage buildings or parking garages, can create near-to-scotopic environments without artificial lighting.

Mesopic lighting is the most problematic lighting condition for the acquisition of sights and reconciliation of focal distances due to the fact that the eye is actively trying to operate in photopic and scotopic light at the same time. In mesopic environments, lighting conditions against unlit areas and objects create photonic barriers. These barriers confuse the eye; attempting to look through a slightly brighter area into a dim area, or the reverse, is forcing the eye to confront a photonic barrier; while it may not appear dark enough for an officer to need artificial light, the dynamic contrast between light conditions causes interpretation confusion and fatigue of the eye³⁰.

The greatest advancement in iron sight technology is the night sight. The adoption of night sights was intended to allow shooters to acquire, align and focus their sights in low light conditions. The

³⁰ Vision under mesopic and scotopic illumination, *Frontiers in Psychology*, Andrew J. Zele1, Dingcai Cao (2015)

effectiveness of night sights is debatable; in a 2001 study³¹, accuracy in varied lighting under static range conditions compared to all black iron sights was found to improve, however Thomas Aveni's research found no improvement in officer hit ratios in shootings since the widespread introduction and adoption of night sights³².

As a trainer, it is common to encounter night sight equipped handguns during low light and shoot house courses (both live fire and force on force); it has been consistently observed by Sage Dynamics that, without the employment of white light in scotopic environments, night sights provide virtually no advantage. In mesopic environments, night sights aid the shooter in acquiring, aligning and focusing on the sights, but do nothing to add additional light to the desired point of aim. This is situational, as every environment is going to be different outside of controlled range conditions, but further speaks to the need for light on demand. With the complicated nature of lighting interaction with the human eye and iron sights established, the last issue with traditional sights is the method in which sights are used.



Constant Threat Focus

The possibility of an officer not seeing their sights under stress is a common point of discussion in law enforcement, which is why it has been addressed in-depth here, and its possibility and probability is an

³¹ [Handgun shooting accuracy in low light conditions: The impact of night sights](#), Policing: An International Journal of Police Strategies & Management, Vol. 24 Issue: 4

³² [Officer-Involved Shootings: What We Didn't Know Has Hurt Us](#), Thomas J. Aveni, M.S. (2003)

issue that trainers must address in their firearms training. Another potential issue with the use of iron sights under use of force stress is focal plane confusion.

With traditional sights, an officer must negotiate three different focal distances to deliver accurate fire. This is accomplished by first recognizing the need for the firearm; a focus on the threat. Then as the duty weapon is brought to line of sight, the eye must accommodate to the rear sight and the front sight to establish sight alignment. Once sight alignment is established and conditions have not changed, the officer may focus on the threat again before finally returning to the front sight for proper sight picture before firing. Three focal planes are the *minimum* needed for this process. Factoring in bystanders, other officers, environmental obstructions, and/or additional threats/potential threats; there can be more than three distances at which the eye must accommodate for fine focus.

All the required data needed for an officer to shoot is taking place *away* from the firearm; at largely uncontrollable distances with many uncontrollable factors in a potentially uncontrollable environment with lighting conditions that the officer may not be able to adequately change depending on equipment.

The plain fact is that the debate point of *its always worked before* in regards to traditional iron sights ignores the shooting statistics that say it isn't working as well as it could. It would be foolish to assume a 100% hit ratio is possible given so many uncontrollable factors in a use of force, however an improvement in officer accuracy is certainly possible with an understanding of why focal issues can and do lead to poor accuracy and mistake of fact shootings.

Iron sights have worked to varying degrees of success since their invention, but they have always worked against human tendency to focus on the threat and created a need to train against human tendency to produce effectiveness. 400,000+³³ years or more of purpose-built hand weapon use. The first projectile weapons, the atlatl, dates to 40,000+ years ago³⁴. The bow is believed to be at least as old³⁵, if not older. What all these weapons have in common is that the user focuses on the threat to aim them.

The first firearm to be used in battle, the hand cannon, was the Battle of Ain Jalut in 1260³⁶. The hand cannon is a crude firearm by modern standards and was aimed by threat focus like the weapons before it. It wasn't until 1450 that the firearms of the time had functional sights³⁷ with improvements to matchlock weapons.

Firearms evolution progressed rapidly once the viability of firearms was seen on the battlefield, and the desire to improve methods to aim the firearm advanced with the desire to produce smaller, more effective weapons. Despite that, the primary method to aim firearms remained iron sights for rifles until the late 20th century and remains the primary method on handguns today.

³³ Lower Palaeolithic hunting spears from Germany, Nature 385, 807 – 810, Harthut Thieme, (1995)

³⁴ Stone Age Kalashnikov, New Scientist, Kurt Kleiner (1999)

³⁵ Inter-group violence among early Holocene hunter-gatherers of West Turkana, Kenya, Nature 529, Lahr, M. Mirazón; Rivera, F.; Power, R. K.; Mounier, A.; Copsey, B.; Crivellaro, F.; Edung, J. E.; Fernandez, J. M. Maillo; Kiarie, C (2016)

³⁶ Transfer of Islamic Technology to the West, Part III Technology Transfer in the Chemical Industries; Transmission of Practical Chemistry, Ahmad Yousef al-Hassan

³⁷ Gunsight, Encyclopædia Britannica, The Janissaries, David Nicolle (1995)

Consider that threat focused aim is over 400,000 years old. Older still if we consider crude weapons such as rocks and fists; while sight focused aim is only 567 years old as of 2017. That is a difference in evolution that cannot be denied.

Does this mean that iron sights do not provide a viable method of aiming and engaging threats? History says *no*, however more effective methods exist, and these methods support 400,000 years of threat focused conflict. This is where red dot optics are the best solution currently available. They allow an officer to remain threat focused.

Liability Under Traditional Training Methods

The foundation for liability regarding training in law enforcement is *Canton V Harris*³⁸. A department's "deliberate indifference" in the failure to provide training, or adequate training opens up liability under § 1983³⁹, potentially for all involved in the administrative chain from instructor up⁴⁰. The possibility for officers to encounter a need for their firearms are known to a moral certainty. Towns, counties, cities, states and the federal government arm their officers with firearms with the reasonable belief that they may need them, and thus the constitutional requirement to train them proficiently exists and falls under *Canton V Harris*.

Firearms accuracy, and the realism of training requirements, not just qualifications, has been addressed in *Popow v. City of Margate*.⁴¹ An Officer of the city of Margate was in a foot pursuit with a suspected kidnapper, the officer fired on the suspect and struck and killed a bystander. The officers training was called into question as being inadequate, wherein the court agreed, they stated;

"The only continuing training was shooting instruction approximately every six months at a range in Atlantic County. However, there was no instruction on shooting at a moving target, night shooting, or shooting in residential areas. Margate is almost completely residential. The possibility that a Margate police officer will in the course of his duties have to chase a suspect in a residential area at night is not in the least remote; therefore, a finder of fact could determine that the City of Margate's training of officers regarding shooting was grossly inadequate within the Leite standard. Furthermore, the officers viewed no films or participated in any simulations designed to teach them how the state law, city regulations or policies on shooting applied in practice."

Further, In *Zuchel v. City and County of Denver*⁴², the court again addressed training programs considering the facts of the case and *Popow V. City of Margate*. In *Zuchel*, the Denver Police Department responded to a disturbance call at a fast-food restaurant. When they arrived, officers were

³⁸ *City of Canton, Ohio v. Harris* :: 489 U.S. 378 (1989)

³⁹ 42 U.S. Code § 1983 - Civil action for deprivation of rights

⁴⁰ *Popham v. City of Talladega*, 908 F.2d 1561, 1564-65 (11th Cir. 1990), *Belcher v. City of Foley*, 30 F.3d 1390 (11th Cir. 1994)

⁴¹ *Popow v. City of Margate* [476 F.Supp. 1237 D.N.J., 1979]

⁴² *Zuchel v. City and County of Denver*, 997 F.2d 730 C.A.10 (Colo.), 1993

told that the subject responsible for the disturbance had gone around the corner of the restaurant. As officers moved to the back of the restaurant, they observed Zuchel, who had his back to the officers, arguing with some teenagers. Someone shouted that Zuchel had a knife. As the officers approached, Zuchel turned toward the officers, at which time Officer Spinharney fired four times, killing Zuchel. A pair of fingernail clippers was found next to Zuchel. Officer Spinharney's partner testified that she was surprised when Officer Spinharney fired because she was right next to Zuchel and about to grab him. At the time of the Zuchel shooting, the only judgement (shoot/don't shoot) training that existed in the Denver Police was a lecture and a movie⁴³. In its decision, the court stated;

“Denver asserts that it can only be liable for an unconstitutional use of deadly force if it had a policy condoning the unprovoked shooting of citizens. However, in City of Canton v. Harris, the Supreme Court expressly rejected the argument that a city is only liable when the municipal policy itself is unconstitutional. Rather, the Court held that ‘if a concededly valid policy is unconstitutionally applied by a municipal employee, the City is liable if the employee had not been adequately trained and the constitutional wrong has been caused by that failure to train.

‘Thus, a city is deliberately indifferent if (1) its training program is inadequate, and (2) the city deliberately or recklessly made the choice to ignore its deficiencies.’”

Other cases, such as Brown V Gray⁴⁴, Tuttle V Oklahoma⁴⁵ and Markham V White⁴⁶ have identified an agencies requirement to insure officers have proper training to adhere to policy, and that the policy be lawful in regard to training.

Law enforcement training has come a long way from its organized beginnings. In the past 20 years, it has arguably advanced more than it did in the 100 years before that, but it still has far to go. Range design limitations, budgetary shortfalls, manpower issues and institutional inertia can all play a small or total part in making training as quality or as legally minimal as possible.

One continued resistance to technology is that it may, in some way, increase a department's liability, or at the very least take longer to implement and train officers to proficiency, which in itself may increase liability. The truth is, when properly implemented, MRDS can help greatly in a reduction of liability use of force incidents, specifically in adverse use of force situations. More than that, MRDS can provide a shorter training path to officer accuracy regardless of prior firearms experience prior to MRDS use.

⁴³ Training to Fail: The Failure of Police Firearms Training For the Real World, Criminal Justice Institute School of law Enforcement Supervision, Greg Stringer (2010)

⁴⁴ Brown v. Gray [227 F.3d 1278, C.A.10 (Colo.), 2000]

⁴⁵ Tuttle V Oklahoma [471 US 808 1985]

⁴⁶ Markham v. White [172 F.3d 486 C.A.7 (Ill.), 1999]

Advantages of Red Dot Optics

As stated previously, it is already established that the red dot optic for rifle use is a preferred and more effective method for aiming and target engagement than iron sights. The US Army standardized red dot optics, the M68 CCO, for all service rifles just after September 11th, 2001⁴⁷, however they were already widespread in Army infantry and more specialized combat units prior to that. An informational study conducted by the 198th infantry brigade during rifle qualifications found a 66% increase in soldier accuracy during qualifications once they had received initial training on their issued RDS⁴⁸.

In a relatively short period of time, the modernization of military optics has occurred for the service rifle. Given the general conservative nature of the Department of Defense to adopt new technologies without thorough testing, this serves as an excellent example that the technological advancements in optics are the future. Which is now.

One Focal Plane

The simplest advantage of the RDS is that it only requires one focal plane shooting; threat/target focus. This means that the use of a red dot allows the shooter to maintain a constant focus on the threat.

For the law enforcement officer, the use of an MRDS on their duty handgun would allow them to maintain a constant focal history on the threat for the entire period of an engagement. Not only does this allow an officer to remove the need to refocus for sight alignment or sight picture, it allows the officer to have a clear picture of the threat up and including the moment where force is used.

When we consider the ever-present possibility of honest mistake-of-fact shootings, the unknown period of time an officer focuses back from the threat to hard focus on their front sight may be all the time it takes for a threat to surrender or otherwise cease to be a threat. This small (or longer) moment of time when the focus is taken from the threat to the front sight has never been available to officers when using proper, foundational instructed sight picture. The MRDS gives officer an ability they did not possess previously. This fact alone makes the MRDS advantageous over any traditional iron sight system in use today. The importance of this cannot be overstated.

With one focal plane shooting for officer handguns, the most common firearm for LE use, the potential reduction in liability is one of its greatest advantages. The RDS and the MRDS is how we reclaim over 400,000 years of human behavior when confronted with a real-world threat.

⁴⁷Dual Path Strategy Series: Part III – Soldier Battlefield Effectiveness, Program Executive Office Soldier G5, Strategic Communications Office (2011)

⁴⁸ BRM/ARM Marksmanship, 198th IN BDE, Command Sgt. Maj. Richard Weik

Accuracy Improvement With the MRDS

The general fundamentals of iron sight use require sight alignment, which is to place the front sight of the handgun into the rear notch and center it as accurately as possible while ensuring the height of the front sight post is equal to the height of the rear sight notch, also referred to as *equal light, equal height*. The text book sight alignment is something that all officers, from academy to retirement will be familiar with from firearms training. They will also be familiar with the commonly repeated phrase of *its not going to be perfect*. Exact sight alignment is difficult, sometimes impossible to achieve because of natural hand tremor, focal issues and the possibility of stress making both of the previous issues worse.

Once sight alignment is established, accuracy is further complicated by sight picture. The requirement to maintain alignment and place the front sight on the desired point of impact. Lighting issues, sight type, distance and movement of the target can complicate this greatly.

Under static range conditions, many officers display great accuracy because they understand the process and they have invested the time to mastering the use of sights. Outside of static conditions, even the best veteran marksman suffer a significant drop in accuracy. This has as much to do with physiology and the more complicated nature of an unpredictable situation as it does with the method of aiming itself.

In 2011, Norwich University conducted a range study⁴⁹ comparing the Trijicon RMR to traditional iron sights. The goal of the study was to identify an advantage in accuracy, if any, of the RMR over traditional iron sights. 27 Norwich University students participated in the study. 13 students used traditional iron sights and 14 students used the RMR. The following details the Norwich University study, their findings are included unabridged. The study was divided into 4 shooting stages;

- Stage One, 15 yard slow fire
10 rounds, untimed
- Stage Two, 5 yard rapid engagement
Starting from a center chest retention hold position and upon a signal from a pro timer engaged the target and fired two shots. The times were recorded for each shot. This exercise was repeated nine more times for a total of 20 shots for Stage 2.
- Stage Three, 10 yard rapid engagement
Stage 3 was identical to Stage 2 except that the distance was increased to 10 yards and the exercise was repeated five times for a total of 10 shots.
- Stage four, 10 yard rapid engagement, multiple threats
Rapid fire with multiple threats at a distance of 10 yards. The subjects faced two targets and, after a timer initiation, fired two shots, one at each target. Students alternated between shooting first at the target on the left and then shooting first at the target on the right. Shot times were

⁴⁹ COMPARATIVE PISTOL PROJECT FINAL REPORT, Norwich University, James Ryan, Robin Adler (2011)

recorded. The targets were placed about six feet apart. This exercise was repeated six times for a total of 12 shots.

Glock 19 9mm handguns were used by both groups. The testing target was a standard IDPA zone scoring target. All fire was conducted from a standing position with a two handed, forward isosceles stance.

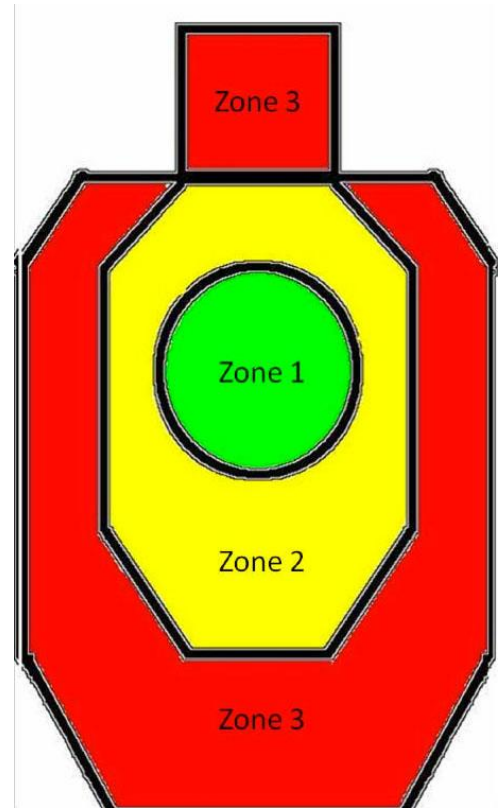

Following is statistical analysis of the four stages.

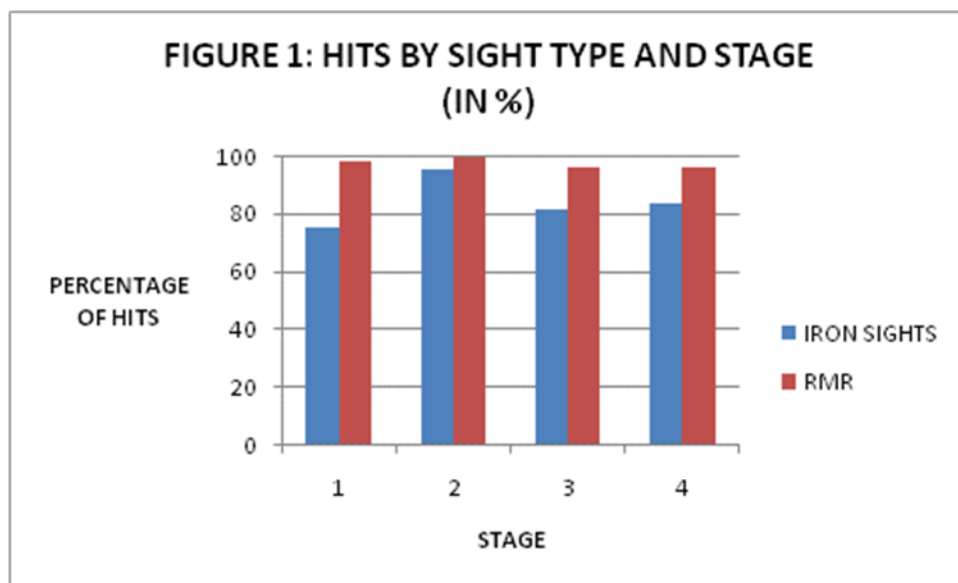

“Hits on target by sight type and stage in percentages. In Stage 1-15 yard-slow fire- the group using iron sights fired a total of 130 shots 97 of which hit the target for a hit percentage of 75 percent. Those using the RMR fired a total of 140 shots 137 of which hit the target producing a hit percentage of 98 percent.

In Stage 2, 5 yard rapid engagement, the group using iron sights fired a total of 260 shots 248 of which hit the target for a hit percentage of 95 percent. Those using the RMR fired a total of 280 shots and hit the target 274 times for a hit rate of 99 percent.

In Stage 3- 10 yard rapid engagement-the group using iron sights fired 130 shots 105 of which hit the target for a hit rate of 81 percent. Those using the RMR fired 140 shots 136 of which hit the target producing a hit rate of 96 percent.

In Stage 4-10 yard rapid fire, multiple threats, data for each group was limited to 12 shooters. Some subjects were confused regarding the changing sequence of aim points and shot at the wrong targets. Data for these shooters were eliminated from the analysis. The group using iron sights fired a total of 132 shots hitting the target 110 times for a hit rate of 83 percent. The group using the RMR fired a total of 144 shots and hit the target 138 times for a hit rate of 96 percent.”

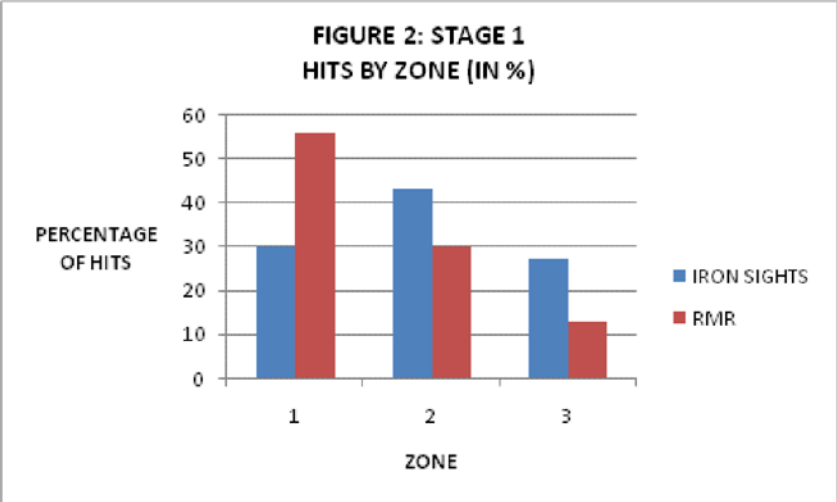

“Figure 2 illustrates hits by sight type and zone in percentages for Stage 1(15 yard-slow fire). Twenty-nine shots, or thirty percent of the 97 shots fired hit the center mass (zone 1). On the other hand 56 percent, or 78 of the 137 shots fired by the RMR group hit the center mass. Forty-three percent, or forty-two shots, fired by the iron sight group, hit zone 2 while thirty percent, or forty three shots, landed in the same area for the RMR group. Finally, 27 percent of the shots fired by the iron sight group hit in the outer zone 3 while only 13 percent of the RMR group hit the outer area.”

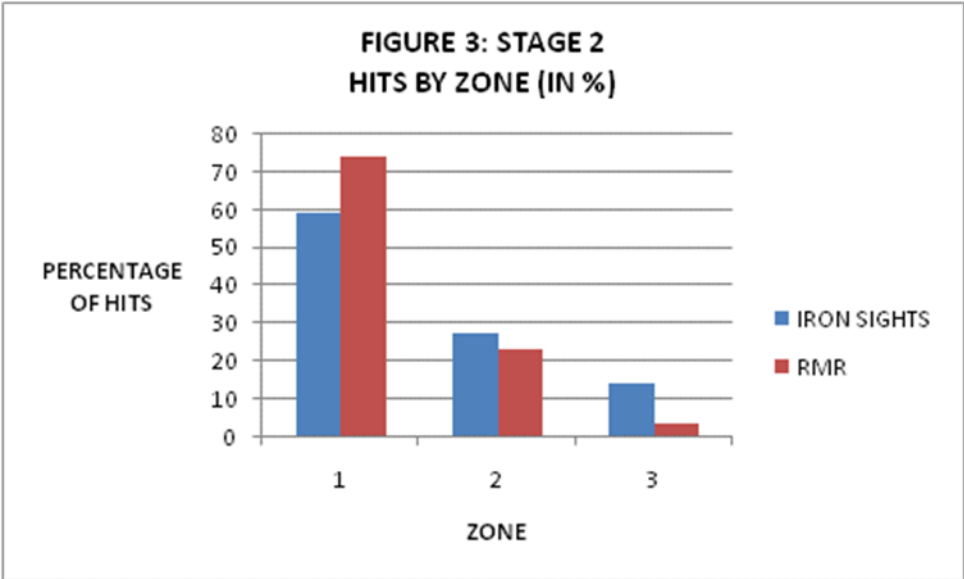

“Figure 3 illustrates hits by sight type and zone in percentages for Stage 2 (5 yard, rapid engagement). One hundred and forty-seven, or 59 percent of the 248 shots fired by the iron sight group that hit the target struck the center mass. This compares with a 74 percent hit rate on the center mass or 204 shots of the 274 hits by the RMR group. The hit rate in zone 2 was 27 percent and 23 percent for the iron sight group and RMR group, respectively. Finally, 14 percent of the hits fired by the iron sight group hit the outer area (zone 3) while only three percent of the RMR group’s hits landed in the same area.”

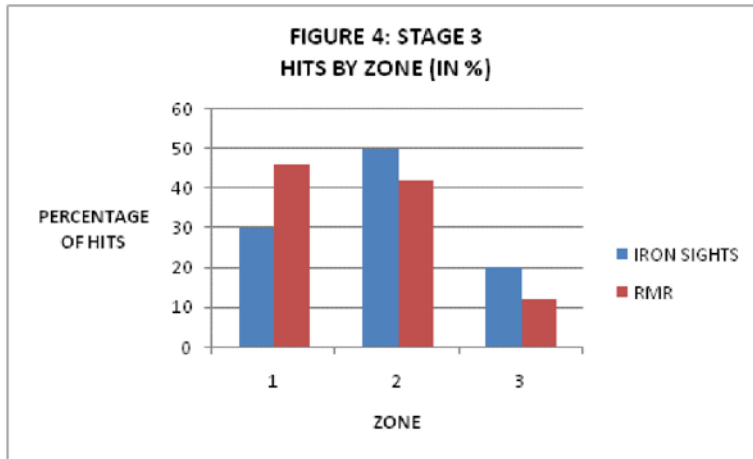

“Figure 4 illustrates hits by sight type and zone in percentages for Stage 3 (10 yard, rapid engagement). Thirty-one shots or 30 percent of the 105 shots fired by the iron shot group that hit the target, landed in zone 1. This compares with 46 percent, or 62 of the 136 hits from the RMR group. Fifty percent of the hits from the iron sight group hit in zone2 while 42 percent of the shots hitting the target landed in zone 2 for the RMR group. Finally 20 percent of the hits for the iron sight group landed in the outer area (zone 3) while only 12 percent of the RMR group’s shot landed there.”

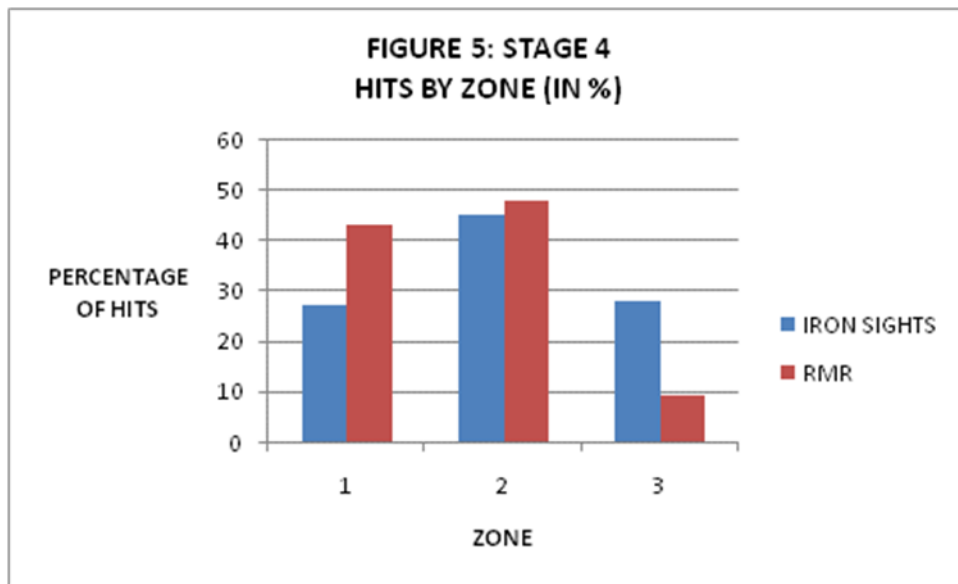

“Figure 5 illustrates hits by sight type and zone in percentages for Stage 4 (10 yard, rapid engagement, multiple threats). The iron sight group hit the center mass, or zone 1 of the target twenty-seven percent of the time. This percentage translates to 30 hits out of the total of 110 hits. Conversely the RMR group hit the center mass 43 percent of the time hitting the center mass 59 times out of the 138 hits. Both groups hit zone 2 with about equal accuracy. The iron sight group had 45 percent of its hits in zone 2 while the RMR group had 48 percent of its hits in the same region. Finally the iron sight group had 28 percent of its hits, or 30 out of 110, in zone 3 while the RMR group had 9 percent or 13 out of 138 hits.”

Participating students experience level was not statistically significant to effect study results to favor either system.

“on the shooting questionnaire asked if the subject had any hunting, military or law enforcement experience. The answers were a simple ‘No’ or ‘Yes.’ The data showed no difference between those who shot with iron sights and those who used the RMR. About half of each group had had some experience. Question 2 addressed pistol shooting experience. Again, about half of each group had had some pistol experience.”

The Norwich University study serves as an example of how effective minimal MRDS use could be. Applied at the academy level, the aggregate MRDS accuracy compared to iron sights would likely show a greater proficiency than like standards trained on traditional iron sights.

MRDS use in Force on Force

In 2014, Sage Dynamics began an open-ended study of MRDS accuracy compared to iron sights during force on force courses. The testing is performed with a Simunitions FX Glock 17 conversion slide milled to accept a Trijicon RMR RM07 MRDS (6.5 MOA dot) as the only sighting system on the handgun. Generally, backup sights are advised on MRDS equipped handguns in the event that the optic fails, though for testing, Sage Dynamics wanted to remove the backup iron sights so that they could not be used unintentionally or otherwise on the MRDS handgun.



The MRDS performance is tracked against iron sight performance on an otherwise identical Simunitions FX Glock 17 conversion slide. For study purposes, a student will participate in 4 scenarios using either the MRDS FX gun, or the iron sight gun. MRDS experience is not required for those evaluated with MRDS use. Participants undergo the same scenarios regardless of which method of aiming is used.

The following data was gathered on 12 students using an MRDS FX gun and 12 students using traditional iron sights.

The 4 scenarios are designed to cover a wide range of potential use of force situations.

- **Scenario A**
Well lit room (photopic lighting), student will enter through a closed door with a holstered weapon. A Single roleplayer is positioned in view of the door, instructed to advance on the student with a prop weapon (large hammer) and use threatening language. Threat role player is instructed to not respond to verbal commands and to raise the hammer to strike. Threat role player’s starting position is no less than 12 feet from the door. Threat role player is instructed to

go to the ground/surrender if they take an incapacitating hit, or a strike to an area that may inadvertently remove their ability to otherwise attack (such as a hit to their weapon hand).

- **Scenario B**
Outdoor area, natural daytime lighting (photopic lighting). Three role players are positioned around the student exit door (student exits from inside to outside). Two role players are instructed to remain near the door and engage in a verbal argument. The third role player (scenario threat) is instructed to approach the arguing couple as soon as the student exits and brandish a firearm (simunitions FX handgun), threatening to kill one of the arguing role players. Threat role player is instructed to not respond to verbal commands and if/when the student draws their firearm, shoot one of the role players and then turn their weapon on the student. Threat role player is instructed to go to the ground/surrender if they take two incapacitating hits, or a strike to an area that may inadvertently remove their ability to otherwise attack (such as a hit to their weapon hand) or a combination thereof.
- **Scenario C**
Indoor area, dim lighting (mesopic lighting) Two threat role players are positioned in opposing corners of a center fed room (door in center of wall). One threat role player (threat 1) is facing the door, the other (threat 2) is placed opposite the laterality of the student (EG; if a student is left handed, the second threat role player is positioned in the right corner of the entry side of the room). Threat 1 is instructed to remain stationary until the student has entered, at which time they are to lift their shirt and display the butt of a firearm (simunitions FX firearm) while demanding the student's wallet. Threat 2 is directed to move between the student and the exit door. Threat 2 is armed with a prop weapon (rubber knife). Threat 1 is instructed to advance on student to receive wallet and only draw their firearm if the student draws theirs. Threat 2 is instructed to only advance if student engages threat 1. Both threat role players are instructed to go to the ground/surrender if they take one incapacitating hit, or a strike to an area that may inadvertently remove their ability to otherwise attack (such as a hit to their weapon hand) or a combination thereof.
- **Scenario D**
Four role players are positioned in a hallway in dim lighting (low mesopic lighting) one role player is given a folding prop knife, the remaining three role players are unarmed. Upon student entry to the hallway, all 4 role players are instructed to verbally assault and threaten the student while crowding the student just outside of arms distance. The threat role player is instructed to get in front of the student's direction of travel and produce the folding knife with a threat to cut the student while remaining outside of arms distance. The role player is instructed to drop the knife as soon as the student draws their firearm and verbally say "I give Up." The other three role players are instructed to flee when/if the student draws their firearm.

Continuity is maintained to the highest degree in the conduct of all 4 scenarios, with detailed instructions to the role players to not go off script or improvise content in any way. Given the live nature of force on force, it is impossible to ensure that each scenario plays out exactly as the others from student to student, but every effort is made to maintain consistency with role players, leaving the students actions as the only unpredictable aspect of the scenario.

Students are provided with their normal compliment of magazines (the number they generally carry) and use whatever their usual carry method is (IWB, OWB, etc).

Student background (LE/MIL or none) and years of shooting experience (rounded to the year) as well as experience with MRDS handguns (rounded to the year, if any) for those using MRDS in scenarios is also recorded.

Students are given no prior knowledge of the scenarios.

Shot placement on threat role players was recorded after each scenario using FX paint marks and role player identification of regions hit.

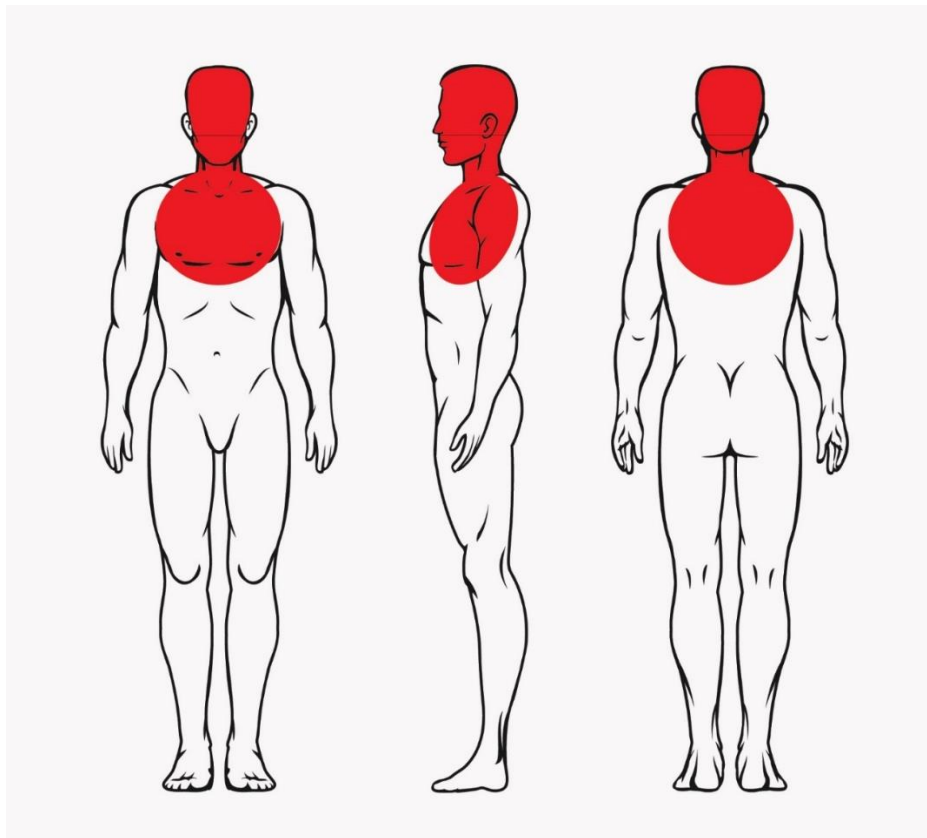

Critical zones are identified in red, detailing the anatomical locations where immediate or delayed medical incapacitation is known to be most likely due to high concentrations of critical structures, organs and tissues.

The following is a statistical analysis of MRDS performance.

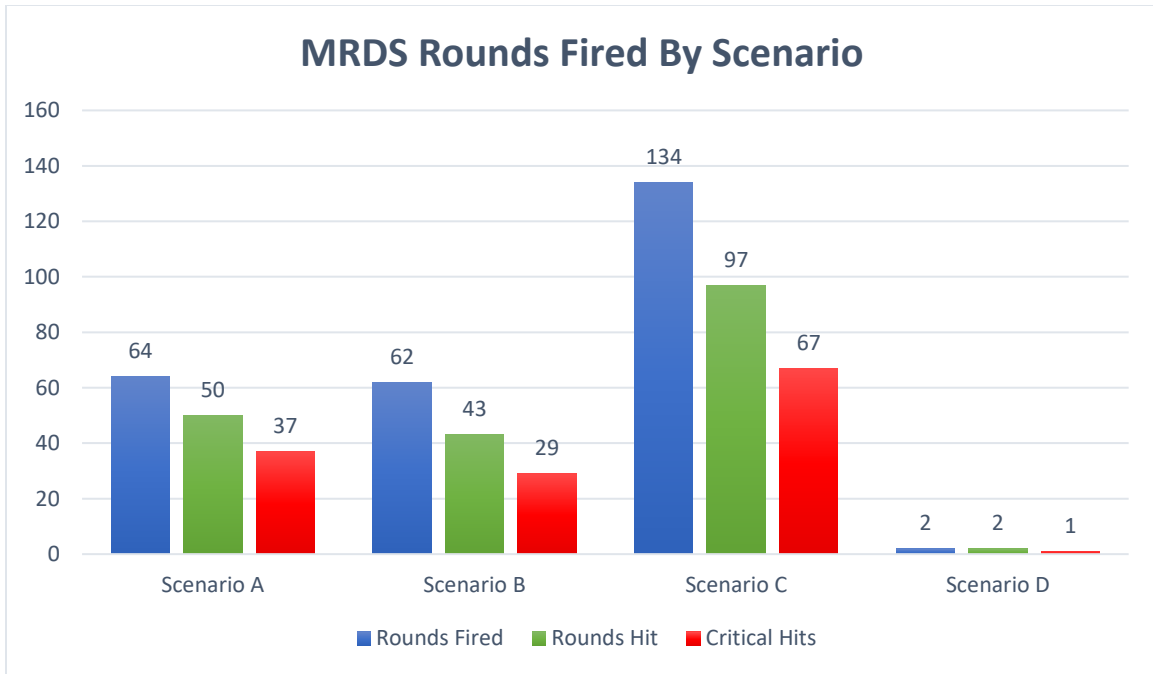

262 rounds were fired over the course of the 4 scenarios, resulting in 192 hits and of those hits, 134 were in critical regions of the body.

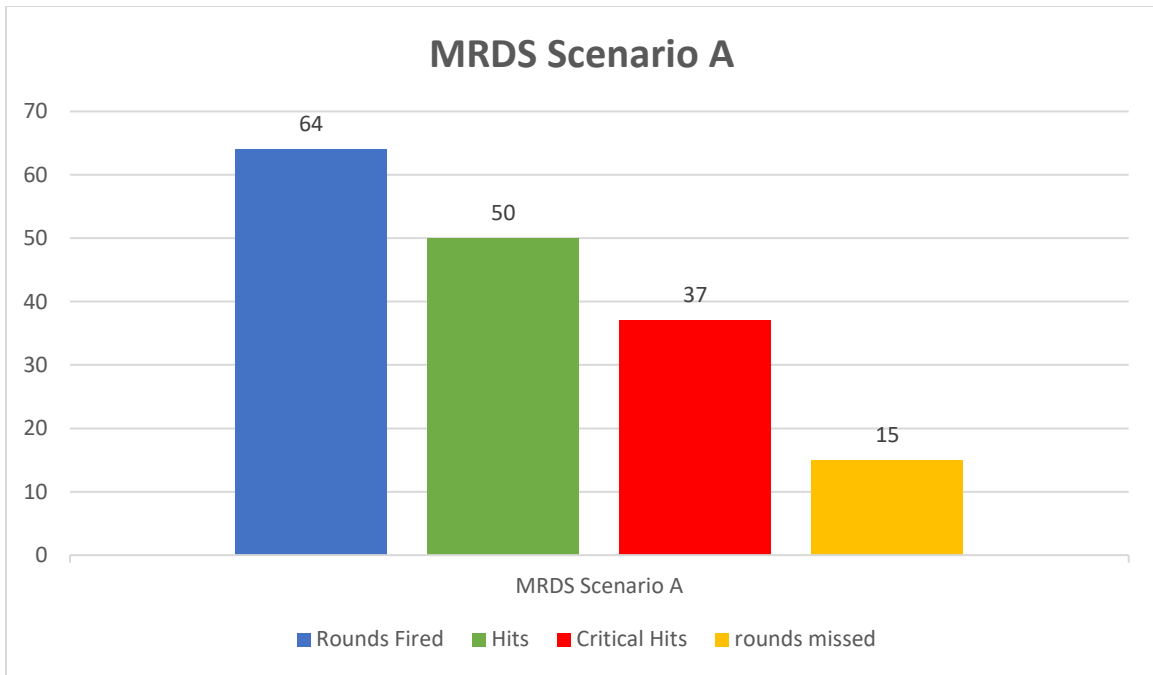

Hit percentage: 78.1%

Critical hit percentage: 74%

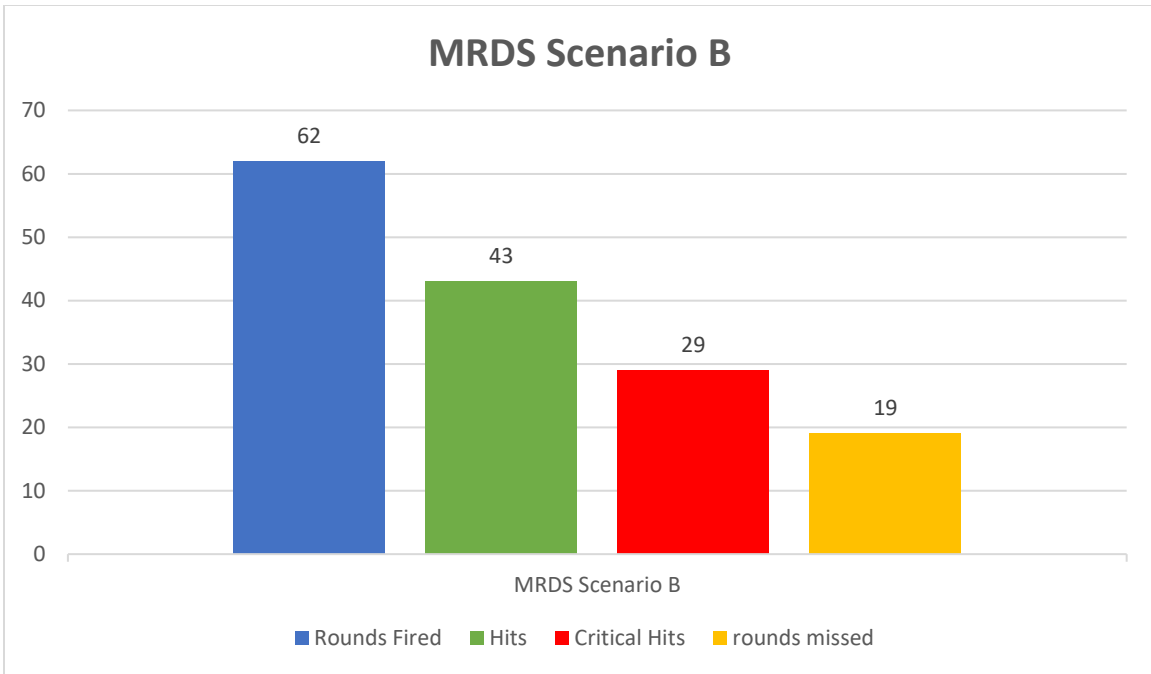

Hit percentage: 69.3%

Critical hit percentage: 67.4%

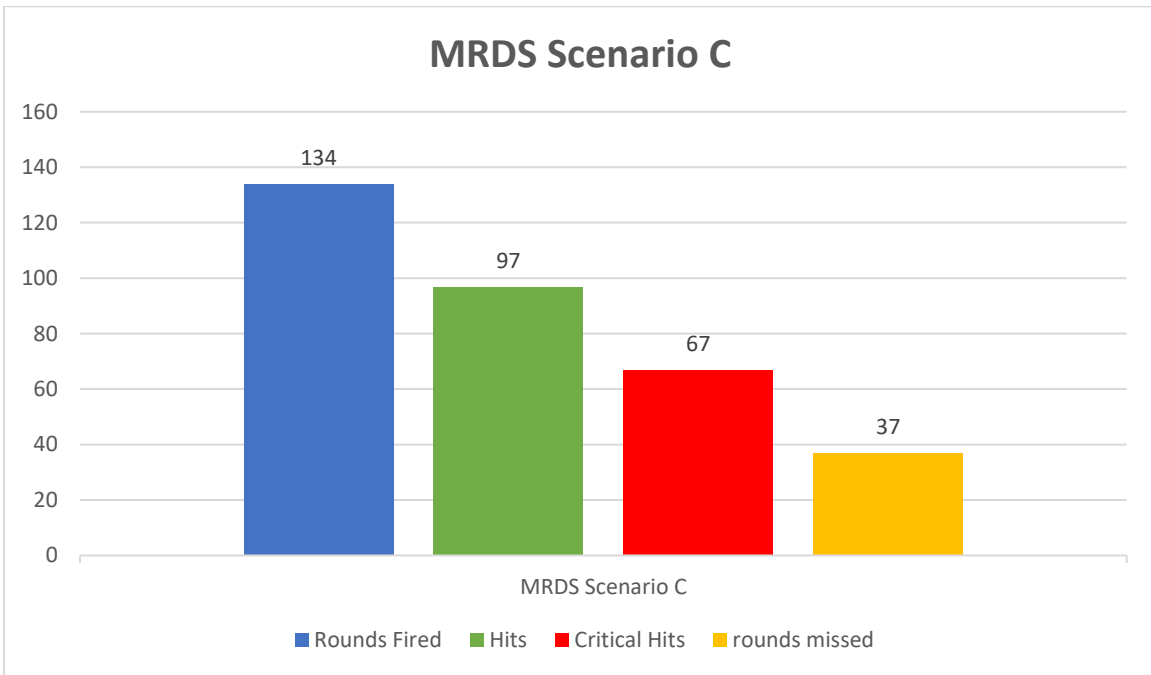

Hit percentage: 72.3%

Critical hit percentage: 69%

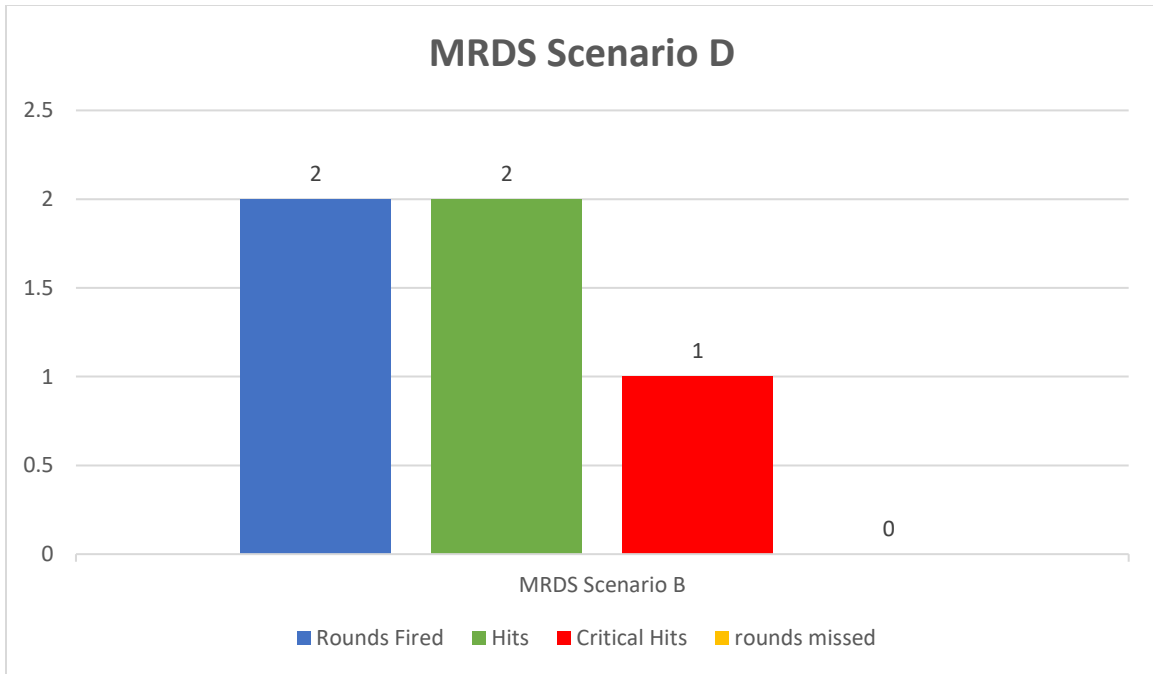

Hit percentage: 100%

Critical hit percentage: 50%

The 12 MRDS participating students were polled on their scenarios with the following questions at the end of each scenario;

Did you focus on the threat?

Did you aim using the MRDS dot?

Did you have trouble finding the dot when presenting the firearm?

Scenario A:

11 of 12 students reported that they focused on the threat.

10 of 12 students reported that they aimed using the dot.

8 of 12 students reported that they had trouble finding the dot.

Scenario B:

10 of 12 students reported that they focused on the threat.

10 of 12 students reported that they aimed with the dot.

6 of 12 students reported that they had trouble finding the dot.

Scenario C:

12 of 12 students reported that they focused on the threats.

12 of 12 students reported that they aimed using the dot.

5 of 12 students reported that they had trouble finding the dot.

Scenario D:

12 of 12 students reported that they focused on the threat.

11 of 12 students reported that they aimed using the dot

1 of 12 students reported that they had trouble finding the dot

The following is a statistical analysis of iron sight use.

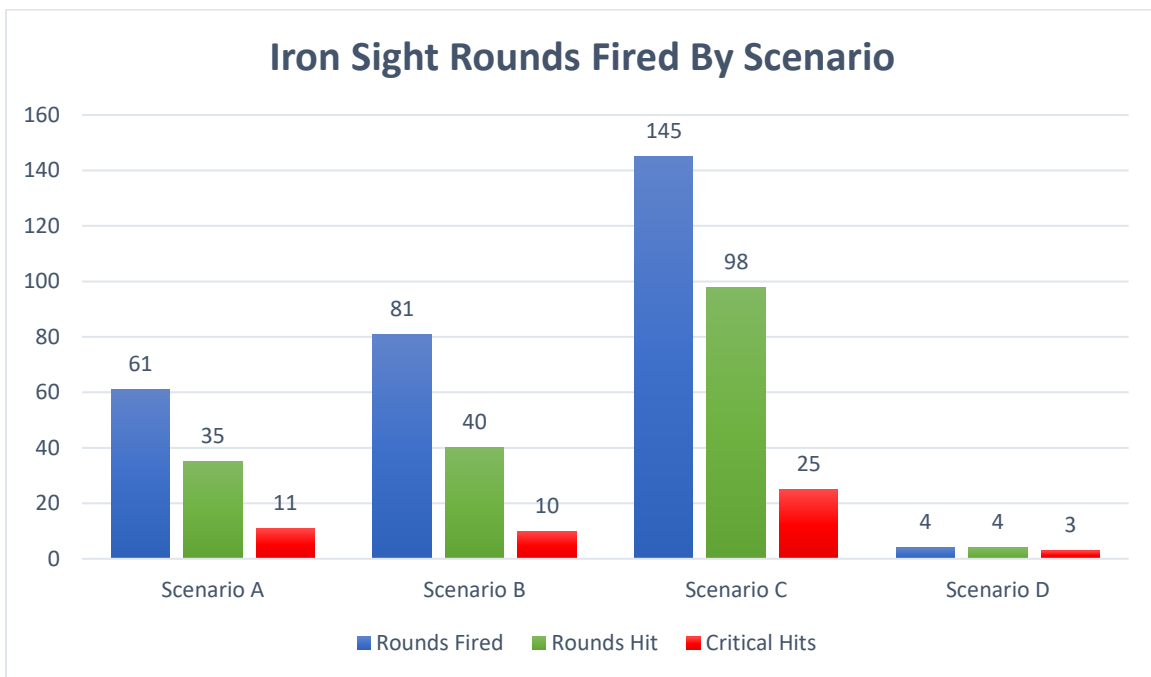

291 rounds were fired over the course of the 4 scenarios, resulting in 177 hits and of those hits, 49 were in critical regions of the body.

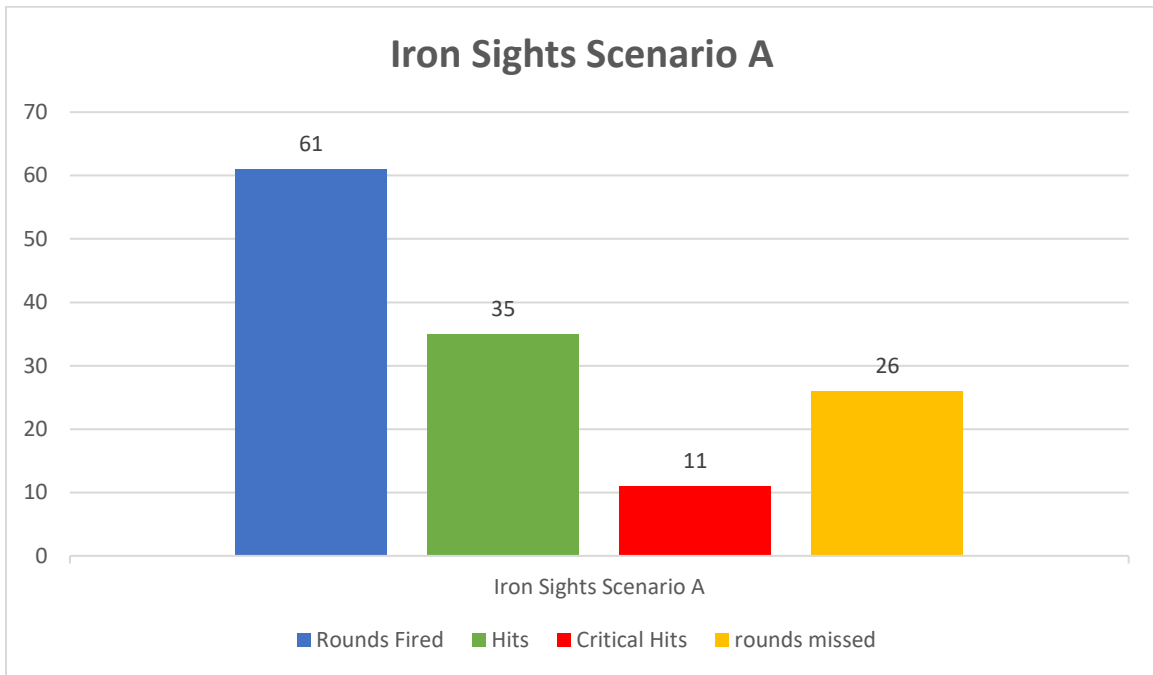

Hit percentage: 57.3%

Critical hit percentage: 31.4%

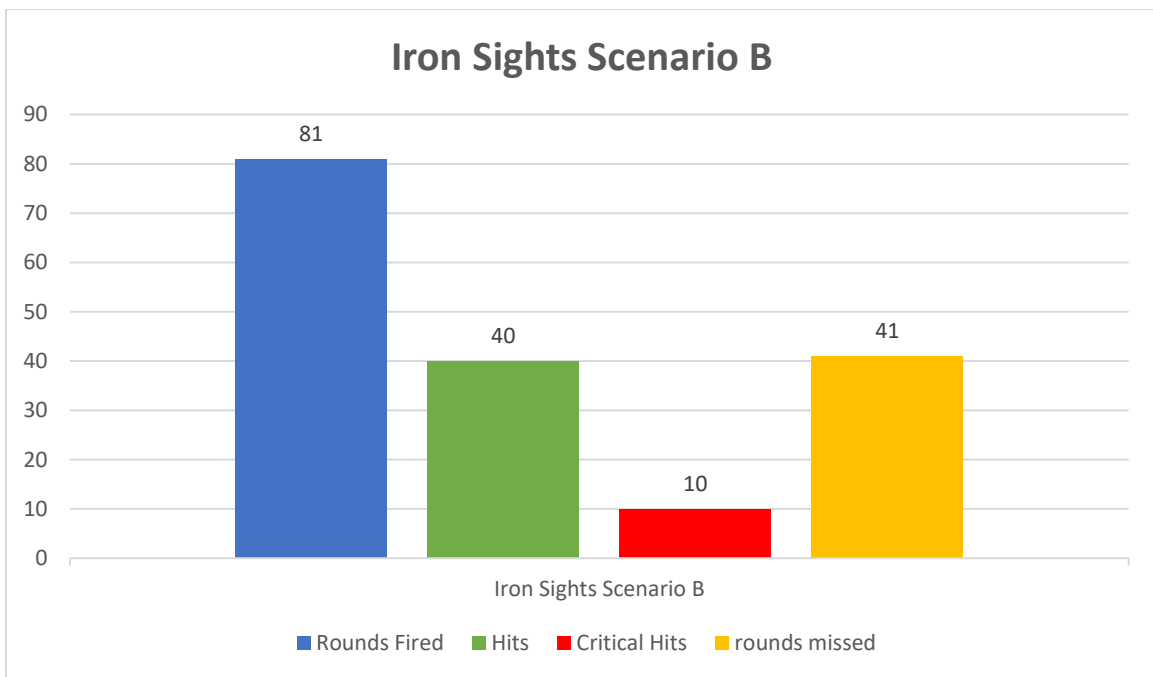

Hit percentage: 49.3%

Critical hit percentage: 25%

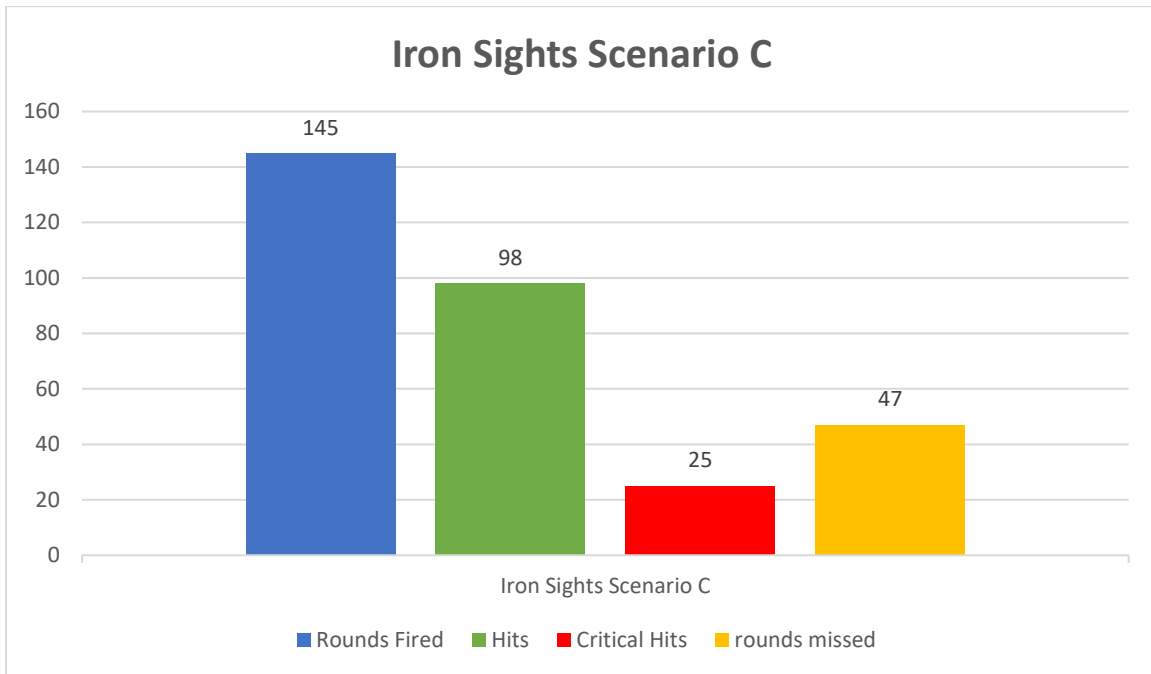

Hit percentage: 67.5%

Critical hit percentage: 25.5%

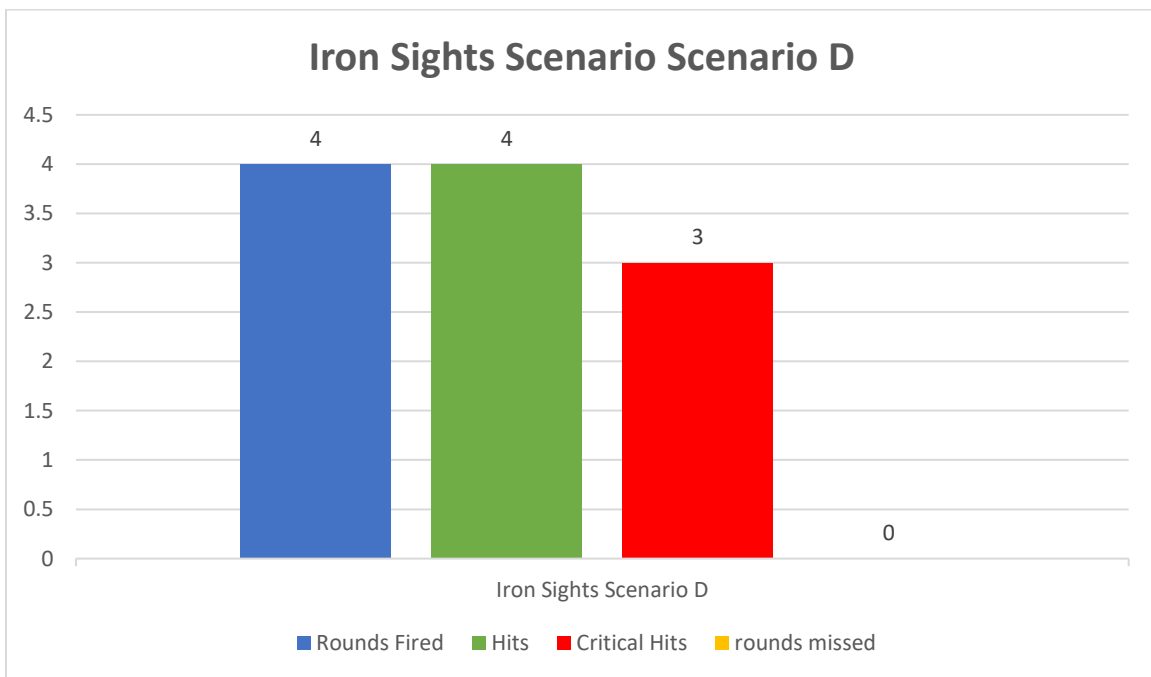

Hit percentage: 100%

Critical hit percentage: 75%

The 12 iron sight participating students were polled on their scenarios with the following questions at the end of each scenario;

Did you focus on the threat?

Did you see your sights?

If no, were you able to find them?

Scenario A:

10 of 12 students reported that they focused on the threat

9 of 12 students reported that they did not see their sights.

Of the 9 students that did not see their sights, 6 indicated that they were able to acquire them eventually.

Scenario B:

8 of 12 students reported that they focused on the threat.

8 of 12 students reported that they did not see their sights.

Of the 8 students that did not see their sights, 1 indicated that they were able to acquire them eventually.

Scenario C:

11 of 12 students reported that they focused on the threats.

10 of 12 students reported that they did not see their sights.

Of the 10 students that did not see their sights, 6 reported that they were able to find them eventually.

Scenario D:

6 of 12 students reported that they focused on the threat.

6 of 12 students reported that they did not see their sights.

Of the 6 students that did not see their sights, 5 reported that they were able to find them eventually.

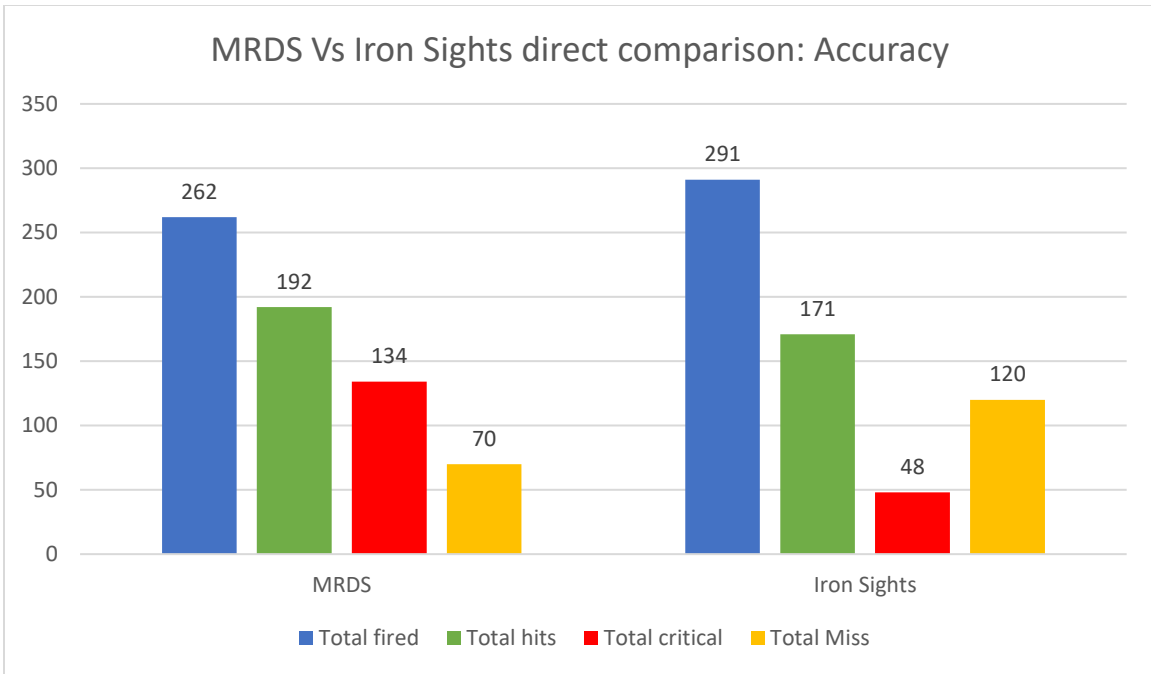

In a direct comparison, there is not a great discrepancy in the number of rounds fired, nor in the number of rounds that were hits, there is a large discrepancy that favors the MRDS in the number of critical hits. It's also worth noting that the number of rounds missed is nearly twice as high with iron sights.

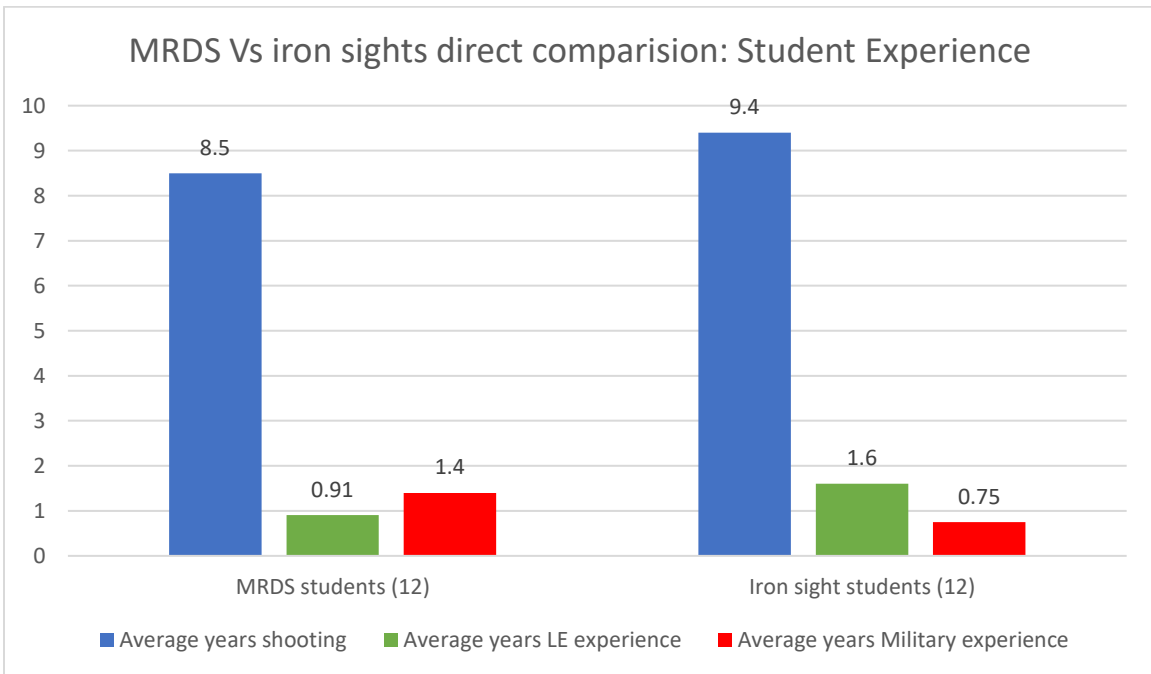

Differences in experience between student's overall years shooting experience was not statistically significant, nor was background of formal firearms training in law enforcement or military a large factor differentiating either test group.

One telling factor between the MRDS test group and the iron sights group was that of the 12 students that used MRDS, only 5 students had prior MRDS experience, and of those 5, the least experience was less than 1 year and the most experience was 3 years.

For visual representation, the approximate location of each hit on scenario threats was recorded for both iron sights and MRDS. The collective hit locations are recorded here by method of aiming.

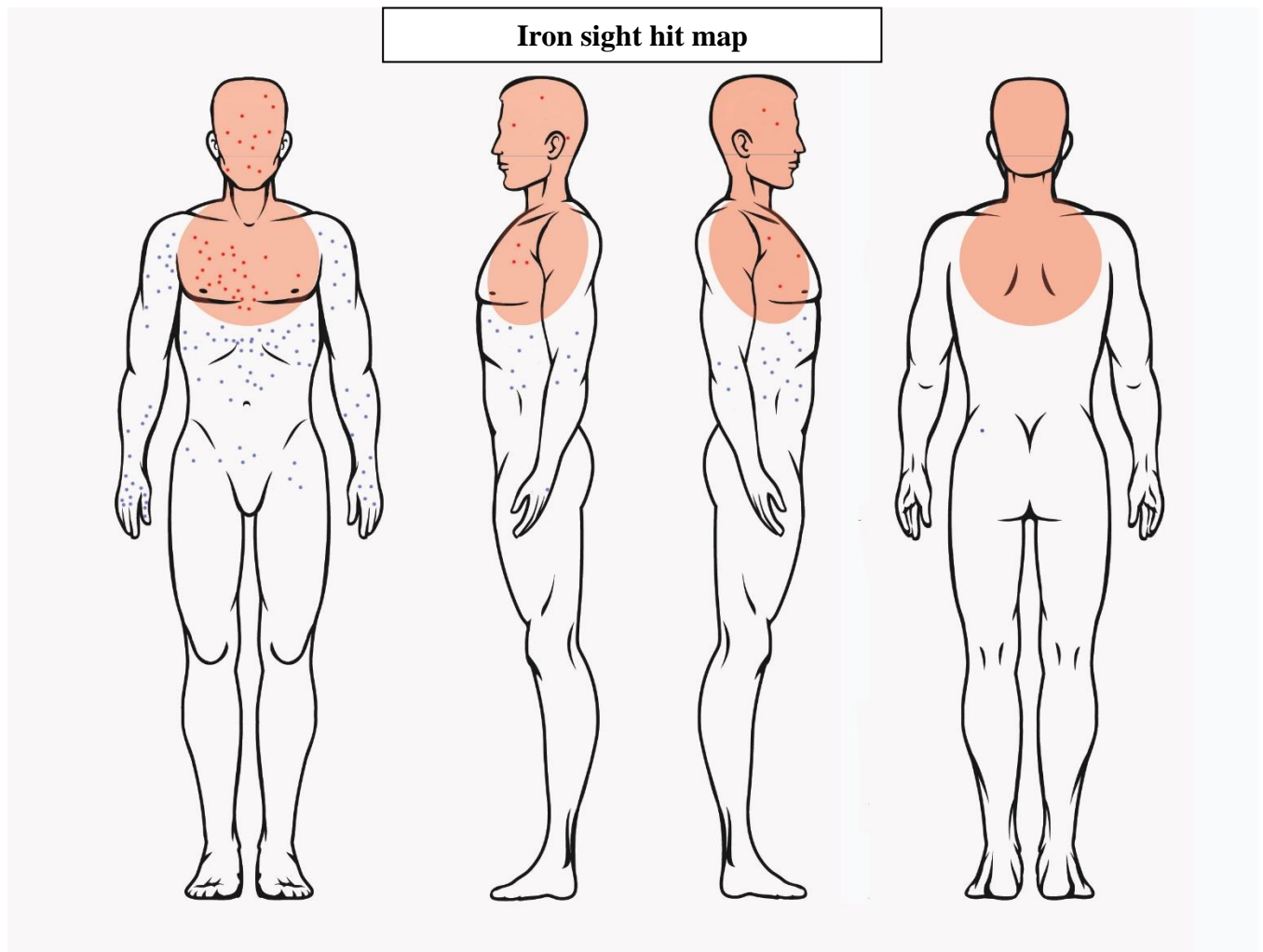

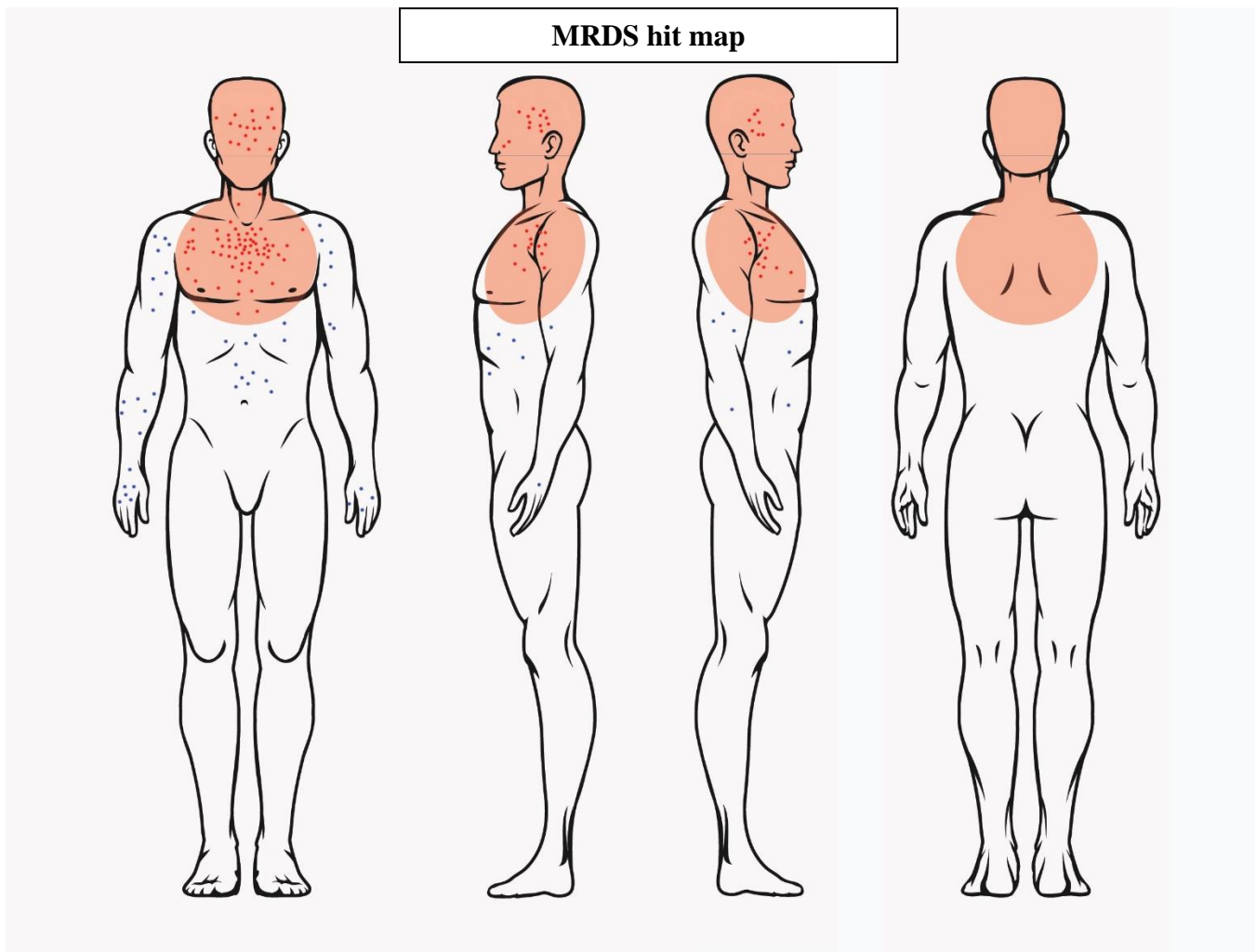

This study is small in sample, covering 24 total students and 4 scenarios per student, however the study is ongoing and data will be published periodically. The data points to a significant trend towards the MRDS being a superior method of aiming for accuracy in more realistic conditions than what has been gathered previously with students working on paper. The Simunitions FX system is not a direct relation of real-world performance, however it is an effective medium for gauging what real-world performance can look like under SNS stress.

MRDS Adaptation and Training

When a department decides to evaluate the MRDS for duty use, proper adaptation and training with an understanding of technology, positives and potential negatives is important. This section will lay out the selection of an MRDS, best practices for training implementation, and the best methods for confronting MRDS issues in training and use.

Selecting an MRDS Model

Selection of a quality MRDS is paramount to proper use in law enforcement environments. Understanding which method of operation and reticle dot size is best for LE purposes is not as complex as one might imagine.

For practical law enforcement use, it is important that the proper method of operation and dot size are chosen. With the 24-hour need for optic use in LE, the best method of operation is the adjustable model RMR. Auto adjust models and dual elimination models do not perform well under varied lighting conditions or when used in mesopic/photopic light in conjunction with a weapon light or handheld light. In dual illumination models, the light will overpower and wash out the aiming reticle. In auto adjust models, the photoreceptor cells are confused by the presence of extreme contrasting light and will not adjust to provide a bright dot. Manual adjust models allow officers to set brightness based on time of day, or conditions. Officers may also choose a specific setting that works well in all possible lighting environments.

The next issue with selecting an MRDS is reticle size. There are many available dot sizes, however in a manually adjustable model, 3.25 MOA and 6.5 MOA are the offered sizes for the RMR.

There are pros and cons to each size; first an understanding of MOA.

Minute of Angle is an accepted measurement of a reticle size; generally explained by how much a reticle will cover at a specific distance. 1 MOA is 1/60th of a degree, covering 1" (1.047") at 100 yards. Meaning a 3.25 MOA or 6.5MOA reticle would cover 3.25" or 6.5" inches at 100 yards, respectively. Either reticle size will provide an officer with an accurate point of aim, however for handgun purposes the size of the reticle can be considered with the size of the front sight post for decision purposes.

An average front sight width is between .125" and .140". At the front iron sight, a 3.25 MOA dot would measure .0362" and a 6.5 MOA dot would measure .0724"⁵⁰. This means that either size is smaller than the likely front sight width on a duty handgun. Providing for brightness settings and available lighting, the dot may appear larger than the front sight, leaving specific measurements somewhat academic. This smaller size, and the floating nature of the reticle allows for a greater degree of precision, and less guess work with smaller points of aim or greater distances in which the front sight can obscure the desired point of impact.

⁵⁰ (reticle MOA/3600) X R + (reticle MOA/100) = reticle size at front sight where "R" is distance from front sight to RMR reticle projection

The 3.25 reticle size can appear to move more in the optic window; this exaggeration of movement is due to the smaller size in relation to an officer's general reference point (the front sight) and the size of the dot in relation to the target. However, the 3.25" allows for greater precision as distance increases.

The 6.5 reticle is closer in size to the traditional point of focus (the front sight) and its overall size in relation to the optic window helps to prevent a great exaggeration of natural movement, however the reticle will cover more of the target as distance increases.

Reticle size should be included in an evaluation of MRDS by the department firearms division to ascertain which size best fits the need of a department given environment and existing training.

It is the recommendation of this paper, based on research and instructing LE Instructors in MRDS use and implementation that departments should make at least two sizes of MRDS reticles available for officers to account for skill level, possible medical conditions (such as astigmatism) and professional marksmanship preference. As officers develop proficiency with their MRDS, it appears to be natural for them to wish to move to a smaller dot size in order to increase accuracy potential over a larger dot and to gain additional target view over what is covered with the larger MOA reticles.

Fundamental Level Instruction

The next hurdle to effective implementation of the MRDS system for LE use is an effective training program to address the difference between MRDS and iron sights. As noted in the MRDS study previously, performance on the MRDS among the tested students was high despite a relative short time per student using the system, or no formal time at all.

Training officers to use the MRDS can be a challenge, but only if the instruction cadre doesn't fully understand the best practices to developing proficiency. From an inception level student to a student who arrives at the academy with prior shooting experience, the methodologies to developing MRDS use are simple and effective. The Norwich University study previously examined serves as a prime example of the foundation of marksmanship that can be established in a short period of time regardless of student experience.

Handgun fundamentals may vary slightly by instructional method, or simply by terminology, however the general explanation of the fundamentals are as follows:

- **Stance**
The most stable physical position to shoot from, ideally with even weight distribution to each leg and torso positioned to aid in recoil control.

- Grip
Beginning with a firm master grip on the handgun with the primary hand while the handgun is still in the holster; meeting the support hand as soon as possible to apply even and firm pressure to the firearm.
- Draw
Economy of motion to minimize drag of the handgun against the holster, rotating muzzle to the horizontal as soon as possible.
- Sight alignment
Front sight even in rear notch, level across the top.
- Sight picture
Front sight post bisecting or just below the desired point of impact (depending on specific firearm factory zero and distance). Front sight clear and in focus, target will be slightly to greatly blurry depending on distance.
- Trigger control
Consistent and even pressure through trigger travel until break, release for reset.
- Follow through
Consistent grip pressure through break of shot, establishment of additional sight picture for preparation of additional rounds if required.

For firearms instructors at all levels, some of the fundamentals are observable; meaning an instructor can watch the student and detect if they are not being applied correctly without ever looking at the target, though rounds on target can and often do confirm their observations. Sight alignment, and sight picture are two of the fundamentals that cannot be observed by the instructor because the instructor cannot see through the student's eyes. This difficulty also exists with the MRDS, however the application of point of aim is simplified over traditional methods and instruction to entry level students made remarkably easier because object/target focus is already well understood by anyone with traditional human vision. They are instructed to shoot in a natural way.

The instruction for traditional sights must still take place, as they remain the backup in the event that the officer's MRDS fails. This will add additional instruction time to firearms programs at the academy level and require officer introduction training to those already out of the academy, but the value gained is worth this additional training requirement.

MRDS fundamentals are simplified, and this simplification leads to more accurate shooting with constant in-focus data on the target. In an Officer Involved Shooting, this means constant information throughout the engagement on the threat, never requiring the eyes to be removed from the threat so that

any detail that may prevent the shooting, no matter how small, is not missed. If the officer is forced to shoot, the single focal plane needed to do so helps prevent visual confusion and allows for greater accuracy.



HANDGUN OPTIC FUNDAMENTALS

STANCE

THE MOST STABLE POSITION AVAILABLE TO SHOOT FROM BASED ON ENVIRONMENT AND SITUATION.

GRIP

FIRM MASTER GRIP UPON DRAW, SUPPORT HAND JOINS FRAME AND APPLIES EQUAL PRESSURE THROUGHOUT PRESENTATION AND FIRE.

DRAW

ECONOMY OF MOTION, SHORTEST MECHANICAL PATH TO FIRING POSITION, SUPPORT HAND MATES THE FRAME AT THE EARLIEST POSSIBLE MEETING.

SIGHT PICTURE

CONSTANT TARGET FOCUS. EYES DO NOT SHIFT FROM TARGET FOCAL PLANE.

SIGHT ALLIGNMENT

OPTIC DOT IS SUPERIMPOSED OVER DESIRED POINT OF IMPACT, FOCAL POINT REMAINS ON TARGET.

TRIGGER CONTROL

CONSTANT AND EVEN PRESSURE THROUGHOUT TRAVEL, AS IN-LINE WITH BORE AXIS AS POSSIBLE. TRIGGER ALLOWED TO RESET UNDER SPRING POWER AFTER BREAK.

FOLLOWTHROUGH

GRIP AIDS IN THE SETTLING OF RECOIL, FOCUS REMAINS ON TARGET. DOT SETTLES TO DESIRED POINT OF IMPACT, PREPARED FOR ADDITIONAL SHOTS IF NEEDED.

The largest hurdles to proper MRDS use at the instructional level are; getting officers used to remaining threat focused upon presentation of the firearm, and aligning the MRDS with their dominant eye. The second common issue is solved by the correct training of the first.

Eye/hand coordination is important to proper firearms training in general, often taken for granted with rifle RDS because the rifle provides four points of contact; shoulder, primary hand, support hand and the cheekweld, which indexes the optic in an optimum location for the eye to acquire the dot.

With the handgun, only two points of contact aid in alignment of the optic body to the dominant eye. The best method for working through this potential hurdle, as it will not happen to all officers, is to instruct officers to drive the firearm to their eyes while looking exactly where they wish to hit the target. If the dot does not appear upon presentation, the officer should move their head until they see the dot while holding the firearm perfectly still. If they find the dot and it is aligned with their desired point of impact, the issue is with their alignment of the firearm to the eye and not with the MRDS to the target.

It is normal for eye/hand coordination to place the firearm in the correct location while not necessarily aligning it perfect with the eye; much in the same way we are able to throw a ball to a specific point without conscious thought as to alignment, these functions occur naturally whether it's a baseball or the alignment of a handgun to a target. This generally isnt an issue with iron sights due to the open nature of their radius and the small, unconscious corrections that are made as the firearm presents.

Introducing the human eye to the equation requires practice, but the time needed for an officer to learn proper use of the MRDS is much shorter, generally speaking, than the time invested in proper iron sight use. Methods that allow for larger points of aim to smaller points of aim as proficiency develops, is the best method to acclimate officers to the MRDS. This process can be accomplished in minutes or hours, reinforced by practice, an officer will become MRDS proficient in a short period of time.

Because the MRDS does not rely on traditional iron sight methods for acquisition or aiming, an officer's experience with iron sights does not directly affect their ability to become proficient with the MRDS. If other fundamentals are sound, efficiency is a matter of proper repetition with a shorter learning curve than that of iron sights. This can be seen in the Norwich University study, with the level of experience compared to the level of performance, and in the Sage Dynamics Force on Force study with the same lens.

Other issues experienced with the MRDS versus iron sights is that the optical dot has a constant movement because of the natural movement of the hands. This movement appears worse than it is. This natural movement is present with iron sights as well, but the size and method of use for the front and rear sights prevents it from being as evident.

The size of the chosen dot for an MRDS can also lead to this natural movement appearing worse than it is. As already mentioned, dot size can further exaggerate this issue, but this movement is relative and does not affect accuracy with the application of proper fundamental techniques.

Under recoil, the dot in the reticle window may disappear as the slide reciprocates and the firearm rises; this is no different than losing focus on the front sight as it moves rearward and up. The return of the dot to proper position for additional shots is dependent upon eye/hand coordination, the input of visual

information and a responding muscular reaction to complete a task, which in this case is the firearm returning to as-close-to-as-possible, the position it was in when the first or sequential shot was made.

The eyes provide the brain with information on the target, such as size and shape, as well as spatial information, the target remains in focus throughout the process. The brain sends this information to the occipital lobe, before it sends it to the frontal lobe. The frontal lobe chooses the best course of action for any corrections that are needed as the optic settles and activates the cerebellum, also known as the motor cortex. which controls motor coordination and movement of the hands. Signals are transmitted through the spinal cord to the needed muscle, in this case in the hands, arms, shoulders, neck etc., and a corresponding reaction occurs.

Spatial awareness in reference to the presentation of the firearm to the target is made far easier with target focus, allowing for more reliable hand/eye coordination⁵¹ than front sight focus. This is possible because the spatial awareness of the target remains constant through the process, as opposed to the eye needing to re-accommodate between the front sight and the target.

One the officer understands eye/hand coordination in relation to the reticle and the target, resetting of the optic to the desired point of aim will become intuitive.

Addressing Optic Failure in Training

Like any electronic device, an optic *can* fail. This possibility exists with all makes of optics, not just MRDS and the possibility is relative to preventative maintenance and environment. For the purposes of training, two types of potential failures should be addressed and trained/practiced for.

Optic dot failure

If the MRDS dot fails, from battery failure or electronic failure (either cause is academic at the moment of failure) the officer can transition back to traditional iron sight shooting or use the window of the MRDS as a ghost ring for closer distance accuracy. The more experience an officer has with iron sights, the easier this transition will be. Potential dot failure must be worked into both department training and qualification standards.

Optic view obstruction

If the window of the optic becomes obscured or blocked, preventing the officer from looking through, an officer must have an understanding of how to overcome this problem in order to maintain accuracy. There are generally two concerns with optic window obstruction; total blockage or glass fogging. Glass fogging is one of the most common concerns brought up regarding MRDS on duty guns. Optic

⁵¹ Target Interception: Hand–Eye Coordination and Strategies, Department of Kinesiology and Health, University of Wisconsin (2007)

obstruction has long been a concern regarding options of all types. The technique to overcome this issue if it happens, no matter how severe the optic obstruction (simple fogging versus an opaque debris such as mud, or a broken lens), occluded eye aiming is possible if the officer has been trained in how to perform it.

When one eye is blocked, a condition known as *Phoria* can occur. Phoria is caused when one eye is blocked, usually at a distance that prevents both eyes from achieving binocular fusion or is of a relative size no matter distance to block the view of the desired point of focus. When the non-dominant eye is blocked, the obstruction may not be processed, or if it is, may not confuse the combined binocular image enough to create an issue with point of focus. If the dominant eye is blocked (such as with an obstructed optic) the dominant eye may either take all data from it or will wander to try and look around the object.

HANDGUN RED DOT FOCAL ISSUES AND CORRECTIONS

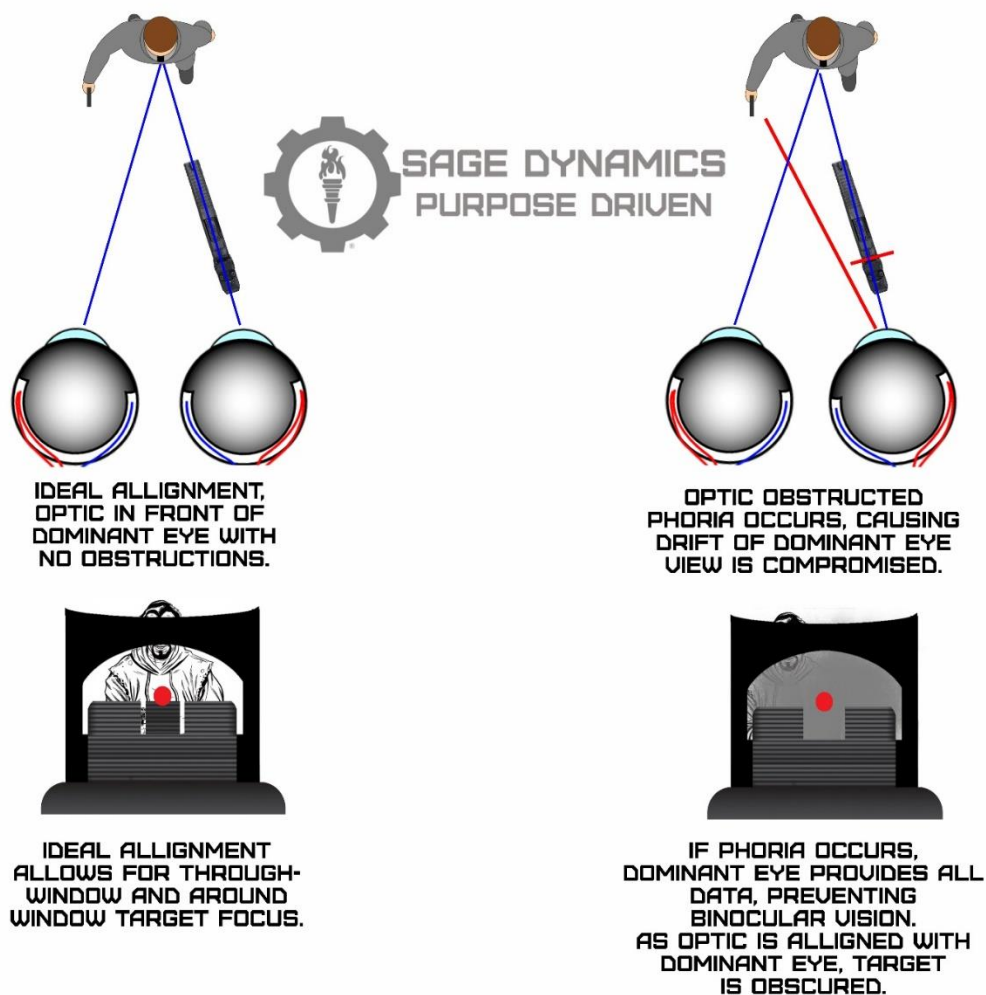

Occlusion is the method in which the non-dominant eye takes over as the primary source of desired information from a focal point. The first red dot optics, as mentioned early in this document, were used with the occluded eye method and the occluded eye gun sight has existed in modern arms as early as WWI.⁵² With an obstructed optic lens, the dominant eye superimposes the reticle over the image being viewed by the non-dominant eye. Occluded eye aiming is a relatively simple technique to instruct and is not dependent on the officer's laterality. It is just as common for the dominant eye to not be the same laterality as the dominant hand as it is for them to be the same side. Since the optic is going to line up with the dominant eye regardless of dominant hand with the handgun, occluded eye shooting as a technique will not be affected by this.

HANDGUN RED DOT FOCAL ISSUES AND CORRECTIONS

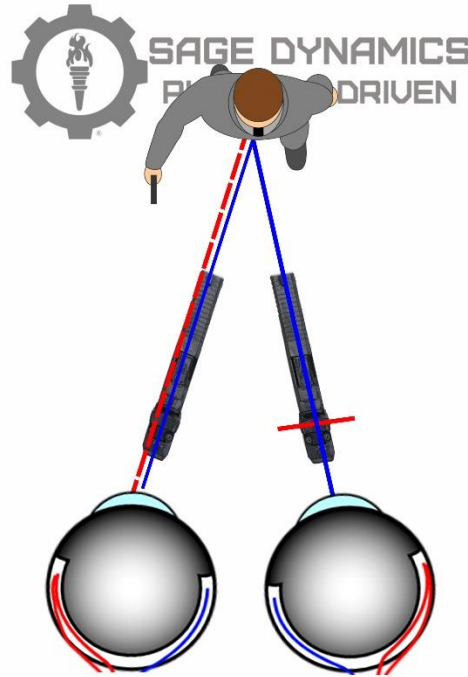

OCCLUDED EYE AIMING TAKES VISUAL DATA FROM BOTH EYES, COMBINING THE IMAGE. THIS WILL MAKE IT APPEAR AS IF THE OPTIC IS IN FRONT OF BOTH EYES.



THE GHOST IMAGE OVER THE NON-DOMINANT EYE WILL GIVE UNOBSTRUCTED TARGET DATA WHILE MRDS DATA FROM THE DOMINANT EYE IS USED TO AIM.

⁵² Surveillance and target acquisition systems, A. L. Rodgers (1983)

In order to introduce officers to this concept, the MRDS can be blocked with painters tape or similar tape to block the lens.

Lens fogging is highly preventative. Firstly, the duty handgun will likely be carried away from the heat generated by the body, and even if it is closer to the body, such as with a concealed inside-the-waistband holster, the heating of the MRDS lens is unlikely to cause a fogging issue in all but the most humid environments. A general comparison is the common fogging of glasses/sunglasses when leaving an air-conditioned environment into an outdoor environment, however this ignores the fact that glasses are much closer to the body and susceptible to excess air via tear duct diffusion.

Pre-treating the lens with a product such as Cat Crap will all but totally prevent fogging, and if this is not done or fogging still occurs in the moment force is needed, occluded aiming can be used until the obstruction condensation clears.

In the event that the ocular lens is blocked, neither the iron sights or occluded shooting can be used. If this occurs and the obstruction cannot be immediately cleared, the officer can use a method known as *Guillotine* or *Bracket* aiming in which the optic body is used as a reference point against the target to estimate the muzzle alignment with the desired point of impact.

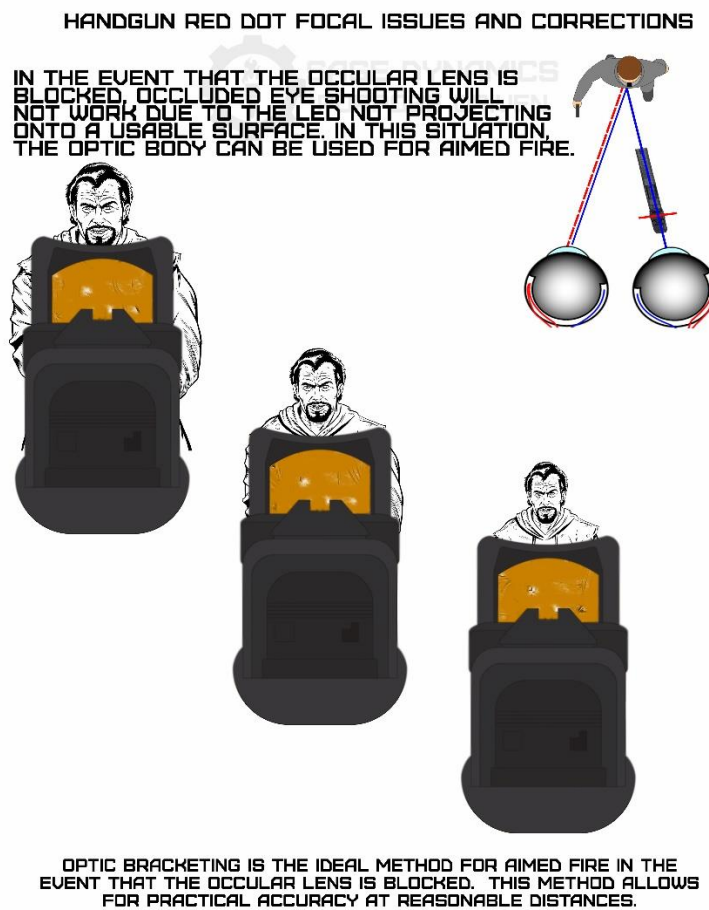

FIG 1

HANDGUN RED DOT FOCAL ISSUES AND CORRECTIONS

BRACKET SHOOTING REQUIRES THAT THE OPTIC BODY BE USED TO ALLIGN THE FIREARM ON THE TARGET USING THE PHYSICAL REFERENCE OF THE TARGET (HEAD, SHOULDERS, ETC). ELEVATION IS CONTROLLED IN THE SAME MANNER.



DEPENDING ON THE OPTIC AND THE FIREARM (DOVETAIL MOUNT, MILLED, OEM OR OTHER MOUNT TYPE) THE OPTIC HEIGHT MAY EXAGGERATE THE ACTUAL POINT OF AIM HEIGHT. GENERAL MECHANICAL OFFSET HEIGHT IS BETWEEN .7 TO 1.2 INCHES.

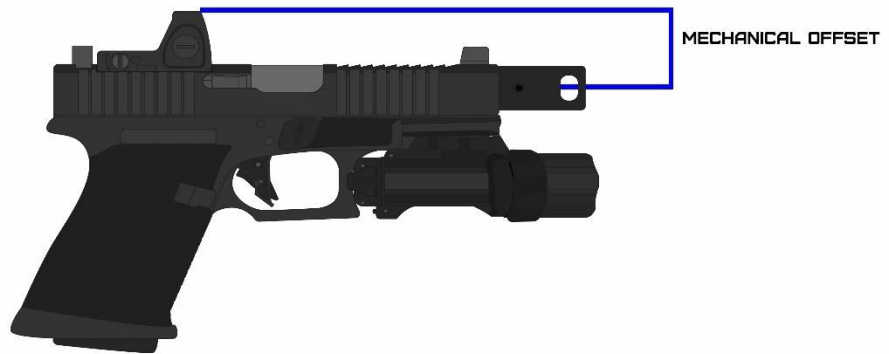

FOR IMPROVED AIMING WITH THIS METHOD, A SOLID WHITE LINE CAN BE ADDED TO THE REAR AND TOP OF THE CENTER OF THE OPTIC SHROUD. THIS CENTERED LINE WILL PROVIDE A SHOTGUN BEAD-LIKE POA AND THE LINE ATOP THE OPTIC SHROUD WILL HELP THE SHOOTER ESTIMATE MUZZLE ELEVATION BY THE DEGREE TO WHICH THEY CAN SEE THE LINE ON TOP OF THE OPTIC SHROUD.

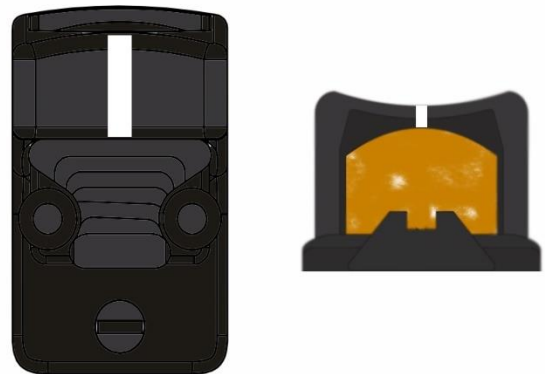

FIG 2

This method does not provide for a high degree of precision but will allow for practical accuracy at reasonable distances.

Utilizing a paint marker, a gross point of aim stripe can be added to the center rear and top of the MRDS shroud, allowing for a bead point of aim. This technique allows for the contrast paint mark to be used in concert with elevation and windage estimation of the entire optic body against the target, and the contrasting paint mark on top of the optic shroud can aid the shooter in judging muzzle elevation by how much of the line they can see when presented to the target.

If the lens is otherwise obstructed or is broken, occluded aiming or bracket aiming will be needed until the optic can be cleared, repaired or replaced. MRDS obstruction should be prepared for, as unlikely as it is, and should also be highly considered as part of department qualifications.

Department Approval, Implementation and Training Plan Creation

-Implementation

Once a department has decided to approve the use of MRDS for duty handguns, a program must be created to transition from iron sights on officer handguns. It is the recommendation of Sage Dynamics that a department not make MRDS duty carry mandatory for all officers. As officer time on duty and time to retirement are always considerations, it will be more cost effective and less disruptive for departments to make MRDS use optional for all currently sworn officers.

At the academy level, making MRDS use mandatory should be strongly considered. All prospective employees attending a police academy should proceed through the entirety of the academy using an MRDS handgun. By approaching the MRDS adoption in this way, senior officers who are nearing retirement are not forced to adopt a technology they may not have the time or inclination to become proficient with, whereas academy level officers will learn the MRDS at the inception level of LE shooting, providing for a more organic adoption of the technology for duty. As mentioned before, it is advisable to make at least two MOA dot sizes available to officers. For officers new to MRDS, a larger dot can aid in foundational skill development. Smaller dots allow for a greater degree of relative accuracy and are generally preferred by officers with MRDS handgun experience.

-Training Plan

At the academy level, MRDS instruction should replace fundamental iron sight instruction. The existing firearms training frame work in most academies will support a direct curriculum replacement, provided academy firearms staff have the prerequisite experience in teaching the specifics of MRDS handgun use. With a direct replacement, officer accuracy will improve at a generally quicker rate than with iron sights, and the time saved in repetition needed to develop skills with the red dot can be allocated towards a block of instruction and course of fire for back up sight instruction. Overall, an efficient training plan

will not require much, if any additional firearms time or allocation of ammunition. Sage Dynamics has observed that skill development and proficiency with the MRDS occurs at a faster rate than with iron sights and because of this advantage, minimal disruption in firearms training timelines at the academy level will occur. Of course, some blocks of instruction during the academy must be augmented.

- **Malfunction training**
In addition to traditional malfunctions, officers should receive instruction on optic failures.
- **General maintenance**
Officers should be taught general optic-specific care in accordance with department SOPs on individual officer's servicing of equipment.
- **One hand manipulation**
With primary or support-hand-only shooting, direct instruction on the use of the optic as a leverage device for manipulating the slide should be addressed.

At the department level, a familiarization training plan should be implemented to ensure officers are going on duty with the knowledge needed to use an MRDS equipped handgun if they did not receive training on one in the academy. If adoption of the MRDS is mandatory for all officers, this training program should include a consolidated block of instruction and a qualification (day and night).

Familiarization training should cover common expected law enforcement skills required for handgun use. Not only will covering common skills allow department instructors to observe and ensure officer understanding and ability, it will aid in building confidence with officers who may not be convinced that the MRDS is superior to iron sights. Departments should make an adequate amount of ammunition available for familiarization.

Ideally, familiarization will include classroom, live fire and force-on-force instruction.

- **Classroom**
 - MRDS history
 - MRDS advantages
 - Department chosen optic operation and features
 - Explanation of parallax
 - Common optic malfunction causes and remedies
 - Red dot/iron sight relationship
 - Officer individual practice plan

- Live fire
 - Establishing sight picture (draw stroke and optical alignment)
 - Target focus marksmanship
 - Dot diagnostics (using dot behavior to identify areas of technique improvement)
 - Acquiring the MRDS from high/low ready
 - Acquiring the MRDS from reloads/mechanical malfunction clearances
 - Optic malfunctions (battery failure, occluded-eye shooting and total optic blockage)
 - Positional shooting
 - Moving targets
 - Shooting on the move
 - Use under low light
 - One hand shooting and manipulations

- Force-on-Force
 - Focus drills, target focus shooting
 - Judgment scenarios (simple and complex)
 - Low-light judgment scenarios (simple and complex)

Sage Dynamics recommendation for *minimum* familiarization follows.

Classroom instruction	4 hours
Live fire range	16 hours
Force-on-Force	8 hours

-Qualification

For day and night time qualifications, there should be little change in the established strings of fire. The MRDS will allow officers, with the proper training, to shoot more accurately, this should not be a reason for making the existing qualifications more difficult. It is virtually unheard of for an officer's sighting system to be called into question in regards to department qualification procedures during a use of force investigation. The MRDS qualification will provide a greater statistical demonstration, as well as real-world ability, of officer accuracy. The technology that allows that accuracy is simply more effective because it allows the officer to see and shoot in a more natural way, it is not the actual reason for accuracy improvement.

Minimal changes should include at least one string of fire that requires the officer to use their back up sights. Its also advisable for departments to include malfunction clearance stings of fire. These changes can either borrow rounds from other strings or add a minimum of 6-10 rounds to cover added strings.

Existing awards for qualification scores, if any, should not be altered to exclude officers qualifying with MRDS against officers using traditional iron sights. The MRDS isn't "cheating" and its important that officers understand that.

Conclusion

Making the case as thorough as possible for MRDS adoption is the entire goal of this paper. With combined research related to iron sights and MRDS, as well as identifying and explaining the psychophysiological aspects associated with aiming under stress. Since the MRDS may appear as a relatively new technology in general and in LE specifically, identifying and addressing all concerned issues to allow a department to make an informed decision is important given the lack of centralized information.

The first adoption of MRDS for duty use in LE isn't specifically known, however they have been in use for a decade or more and continue to be adopted as progressive agencies strive to increase officer accuracy and reduce possible mistake-of-fact uses of force.

Research into MRDS will continue; Sage Dynamics has indefinite research in progress for both live fire and force on force, with results published periodically and this white paper will possibly jump start more research at the department level to further establish the case for MRDS adoption.

Ultimately it is up to the individual department to adopt an evaluation regimen for possible adoption or approval of MRDS on duty handguns. Sage Dynamics cannot direct the best methods for evaluation for all departments, but a solid standing point is the established department qualification. As the qualification is the legal standard for an officer's defensibility in many cases in an officer involved shooting. Allowing department firearms cadre and administration see direct results of improved accuracy with participating officers. Selecting test participants based on consistently high and consistently marginal scores would establish a strong baseline for a proof of concept at the department level.

Departments must be prepared for the full adoption of MRDS systems, this means maintaining replacement optics on hand and having complete MRDS guns available for duty gun replacement in the event of an officer involved shooting. This increases equipment costs, however it should be clear at this point in the paper that the adoption of MRDS duty guns will save departments money in other areas.

In closing, the validation for MRDS as an increase in officer effectiveness has been well established by this white paper and will assist in adoption of MRDS on duty handguns, it is now up to law enforcement to further their never-ending efforts to increase officer efficacy.

In-Use Agency Contacts

Below is a list of points of contact for agencies already using MRDS duty guns in full, part, or optional to the officer. This list is not total.

Lisle, IL Police Department. Jim Dexter tacticalsoundtc@gmail.com

Leander, TX Police Department. Ben Girdler bgirdler@leandertx.gov

Billings, MT Police Department. David Firebaugh firebaughd@ci.billings.mt.us

Deephaven, MN Police Department. Ethan Reed Ethanr@deephavenpolice.com

Naperville, IL Police Department. Colton Parchem parchemc@naperville.il.us

Rockwood, MI Police Department. Randy Krause pdchief@rockwoodmi.org

Sugarland, TX Police Department, Matt Shockey mshockey@sugarlandtx.gov

Saint Albans, WV Police Department, Wayne Fisher Mfisher@saintalbanspolice.com

George Mason Police Department VA Det. Jacob Simkoviz jsimkovi@gmu.edu

Charleston, IL Police Department Ryan Feder rfeder127@gmail.com

Port of Seattle, WA Police Department Joey Russo Russo.j@portseattle.org

Oakbrook Terrace, IL Police Department, Thomas Tomopoulos ttomopoulos@oakbrookterrace.net

Calgary Police Service, Calgary, Alberta Canada Stefan Van Tassell SVanTassell@calgarypolice.ca

Bloomington, IN Police Department, Zachary Weisheit weisheiz@bloomington.in.gov

Chamblee, GA Police Department, Robert Bodron rbodron@chambleega.gov

Walla Walla County Sheriffs Office, WA Thomas Beyer tbeyer@co.walla-walla.wa.us

Ames, IA Police Department Nate Rivera nrivera@city.ames.ia.us

Greenbrier County Sheriffs's Department, WV Billy Mitchell Billy.Mitchell@greenbriercounty.net

Waukesha, WI Police Department Det. Scott Knipfer SKnipfer@waukeshacounty.gov

Santa Rosa, CA Police Department Ryan Cadaret rcaddy2@gmail.com

Tracy, CA Police Department Det. Nick Heaney, Nick.Heaney@tracypd.com

Santa Cruz, CA Police Department Chris Galli Cgalli@cityofsantacruz.com

Orange County Sheriffs Department, CA Gabe Rivera grivera@ocsd.org

Abilene, TX Police Department Chance Wideman chance.wideman@abilenetx.gov

Munster, IN Police Department Nathan Martin nmartin@munster.org

Australian Federal Police, Australia James Brennan james.brennan@afp.gov.au